

# OfficeMart

#Sololosmejoresmuebles



## Product Catalogue



supporting children and their families for life

seating • changing & showering • therapy • sleeping • desks & tables • toileting & bathing • sensory • standing

# welcome

Since 1986, Smirthwaite has developed and retained its reputation as one of the leading designers & manufacturers of special needs equipment. In that time, we have dedicated ourselves to finding and providing effective solutions that offer significant benefits to babies, children & young adults in their daily lives. Working closely with children, parents, carers and therapists, we have developed a broad range of seating, standing, tables, desks, toileting, bathing, changing, showering, sleeping, therapy and sensory products.

## Innovation in our design

Special needs equipment is often overly complex, difficult to use and expensive to maintain. At Smirthwaite, we believe in well-made, easy to use products that stand the test of time. Through close consultation with leading therapists, parents and end users, we ensure our designs offer numerous clinical benefits whilst maintaining a customer-centric and innovative approach.

## Warranty & Servicing

All of our products come with a two year warranty as standard. An inspection, maintenance, service and repair facility for all Smirthwaite products is available to you, for complete peace of mind. This can be scheduled at a time that is convenient for you.

Call our Customer Services team today on **01626 835552** or e-mail **info@smirthwaite.co.uk** to book your service, inspection or repair.



## Easy to clean

All of our products are easy to clean. For instance, our wooden chairs have anti-microbial properties that ensure surfaces are kept hygienic. This helps to reduce any risk of cross infection and is especially useful in multi-user environments such as nurseries and schools.

All our upholstery is carefully chosen due to its clever material make up that contains antibacterial agents that help against the spread of MRSA, E coli and other bacteria. The Dartex upholstery on our Sleep systems, Juni's and Strato's contains Biostatic (anti-mycotic) coatings and this provides an impenetrable barrier to virus and bacteria.

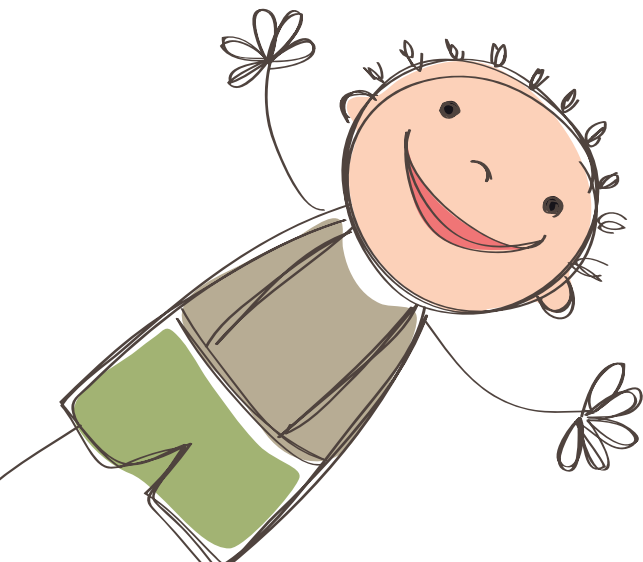

# contents

## seating

brookfield	5
corner chair	13
felix	15
foxdenton	17
hardrock	19
heathfield	25
hip spica	31
indiGO	33
juni	37
sam	43
samba	45
strato	49
sunni	53
zoomi	55

## desks & tables

desks	59
tables	63

## standing

supro	65
whirl	69
buddy	71
chi chi	71
sta	71

## toileting & bathing

bath chair	72
bath corner chair	73
chailey	75
combi	79
potty chair	81

## changing & showering

easi-lift changing	83
--------------------	----

easi-lift showering	85
easi-lift shower fixed	87
easi-lift shower manual	89
hi-riser	91
hi-riser showering	93
mobi changer	95
mobi heavy duty changer	97
mobi showering trolley	99
changing & showering	101

## therapy

conductive edu. packs	102
footrests, steps & bars	103
ladders	104
ladder back chairs	105
plinths & accessories	106
therapy bench & bolster	108
wheely stools	109

## sensory

ball trails	110
body roller & bumper	111
dream swing	111
frames & swings	112
ramp & scooters	115
rocking ball	116
rocking horse	116
rokka	117

## sleeping

little dots	119
snooooooooze	121

## added extras

helmets	124
harnesses	127
sandals	128
batteries	128

# brookfield

## Increased stability

The Brookfield is a robust chair for children from 2 years old to young adults who require moderate levels of postural support when seated. The Brookfield has a unique moulded back as standard to promote central alignment whilst your child is seated.

## Greater adjustability

The Brookfield offers seat height and depth adjustability. As an additional feature, the back can also be adjusted in height. This allows even greater flexibility and enables the chair to grow with your child. The Brookfield chair comes complete with moulded back, contoured seat, a buckle pelvic strap and height adjustable armrest as standard.



a robust and  
customisable chair  
available with a high or  
low back

## Perfect for customisation

Each child is unique, which is why the Brookfield has been carefully designed to provide your child with a high level of customisation; this means that the needs of your child are brought to the forefront. By using the chair and the accessories together we can offer a highly tailored solution.

New Feature!  
The Brookfield is now  
available on an electric  
hi-lo base



Pictured on a new electric hi-lo base.



## Standard key features



Moulded back



Contoured seat



Buckle pelvic strap

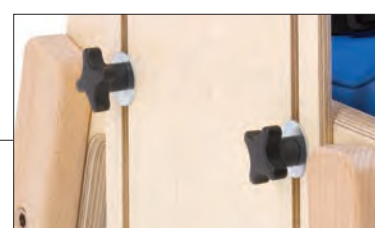

Height adjustable arm rests

## Brookfield technical data

all dimensions in mm unless otherwise stated

Please choose your Code from High (HB) or Low (LB) back chair.

■ Instructional video available online

Code	Size	Seat height*	Width	Seat depth	Back height	Max. user weight (kg)	Product weight (kg)
6569	0LB	205-280	280	210-310	315-415	45	10
6570	0HB	205-280	280	210-310	390-490	45	12
6571	1LB	255-330	325	220-320	365-490	55	12
6572	1HB	255-330	325	220-320	465-585	55	14
6573	2LB	280-380	365	275-385	410-530	65	18
6574	2HB	280-380	365	275-385	495-615	65	20
6575	3LB	345-445	435	355-465	450-590	75	23
6576	3HB	345-445	435	355-465	530-670	75	25
6577	4LB	425-575	435	425-570	505-645	85	28
6578	4HB	425-575	435	425-570	570-710	85	30

The Brookfield chair comes complete with moulded back, contoured seat, a buckle pelvic strap and height adjustable armrest as standard. Available in bariatric sizes up to a user weight of 150kg. Please contact us for further details.

\*Height of chair with contoured seat, the height with a flat seat is 25mm less.

# brookfield

## optional accessories



### Moulded t-shaped back<sup>1</sup>

CODE BK059, BK061, BK063, BK065

\*BK060, BK062, BK064, BK066

Enables loose contour with the body  
Positions asymmetric lateral support



### Moulded back with cut-out lateral supports<sup>1</sup>

CODE BK019, BK021, BK023, BK025

\*BK020, BK022, BK024, BK026

Enables close contour with the body  
Positions asymmetric lateral support



### Backrest extension support

CODE HT006 - HT010

Provides back and head support



### Flat t-shaped back<sup>1</sup>

CODE BK067, BK069, BK071, BK073

\*BK068, BK070, BK072, BK074

Enables asymmetrical position of  
quick fix supports



### Flat back with cut out for lateral supports<sup>1</sup>

CODE BK035, BK037, BK039, BK041

\*BK036, BK038, BK040, BK042

Positions asymmetric lateral support



### Fully adjustable back<sup>1</sup>

CODE BK083, BK085, BK087, BK089

\*BK084, BK086, BK088, BK090

Facilitates quick fix lateral and  
pelvic supports



### Quick fix lateral supports (pair)<sup>1</sup>

CODE WG004 - WG006 (fixed)

WG001 - WG003 (flexi)

Tray with cut outs available

### Quick fix pelvic supports (pair)<sup>1</sup>

CODE WG007

Provides additional trunk and  
hip support



### Pelvic cushions – single thickness (pair)<sup>2</sup>

CODE CS005 - CS045

Provides hip and thigh support

Available in various sizes



### Pelvic cushions – double thickness (pair)<sup>3</sup>

CODE CS050 - CS090

Decrease seat width. Available in  
various sizes. Supplied loose but can  
be attached with velcro on request

<sup>1</sup> For low & high\* back; available in sizes 1 – 4

<sup>2</sup> Available in size 25mm, 38mm, 50mm, 62mm & 75mm

<sup>3</sup> Available in sizes 25+25mm, 38+25mm, 50+25mm & 62+25mm

# brookfield

## optional accessories



### Pelvic wedge cushions (pair)<sup>2</sup>

CODE CS095 - CS126

Provides additional support  
Available in various sizes



### Pommel

CODE PL010, PL012, PL013

Encourages hip abduction



### 4-point pelvic strap<sup>1</sup>

CODE HN070 - HN073

Provides firm contoured support to stabilise hip position  
Available in sizes 1 - 4



### Strap for lateral supports<sup>1</sup>

Fixing with a buckle  
CODE ST020 - ST022  
Fixing in velcro  
CODE ST046 - ST049



### Lumbar pad

CODE PD007 - PD010

(moulded backs)  
PD002 - PD05 (flat backs)  
Maintains pelvic position

 Colour Ranges  
See page 129 for colour options



### Sacral pad

CODE PD018 - PD021

(moulded backs)  
PD013 - PD016 (flat backs)

Assists in maintaining pelvic position

<sup>1</sup> Must be factory fitted

<sup>2</sup> Available in sizes 75x50mm, 75x62mm, 75x75mm, 100x75mm



# brookfield

## optional accessories



### Independent adjustable footrest

CODE 4187

Portable, height and angle adjustable foot support  
Can be used with a variety of products



### Mobile dolly base

CODE DL001 - DL005

Facilitates easy manoeuvrability



### 4 glisdomes

CODE GD001

Comes complete with screws to fix under chair leg



### Kicking board<sup>1</sup>

CODE KB006 - KB009

Maintains foot position  
Recommended for a child who wraps feet around chair legs



### Knee blocks

CODE KN001

Provides knee position  
Encourages hip abduction



### Tray

CODE TR002 - TR005

Provides trunk support  
Additionally can be used for activities, playing and feeding



### Tray handrail half width

CODE HR004

Helps to stabilise upper limbs  
Additionally can be used to attach toys



### Tray handrail full width

CODE HR001 - HR003

Helps to stabilise upper limbs  
Additionally can be used to attach toys



### Independent adjustable split seat<sup>1</sup>

CODE SE021 - SE024

Accommodates leg length discrepancy  
Only available with sizes 1 – 4 chairs

<sup>1</sup> Must be factory fitted at the time this product is ordered





### Ski & half footrest

CODE SK007 - SK011

Provides foot support and offers greater stability



### Ski & full footrest

CODE SK018 - SK022

Provides foot support and offers greater stability



### Reversible footboard

CODE FB001 - FB005

Provides foot support  
Prevents unwanted chair movement



### Folding footrest<sup>1</sup>

CODE FR014 - FR017

Facilitates standing transfer  
Foot plates fold away to the side



### Adjustable footrest

CODE FR001 - FR004

The sides help to keep feet contained  
Easy to adjust footrest



### Footplate & straps<sup>2</sup>

CODE FP002 - FP005

Ensures that feet are firmly in position



### Minimum raise mobile base

CODE MB001 - MB004

Facilitates standing transfer  
Easy manoeuvrability  
Only available with sizes 1 - 4 chairs



### Adjustable height push handle<sup>3</sup>

CODE PH016, PH018, PH020,  
PH022, PH024 (low back chairs)

Adjusts to achieve optimum push position



### 4 mobile legs with 75mm castors

CODE LG001 - LG005

Facilitates in moving the chair  
Castors can be locked

<sup>1</sup> Must be factory fitted at the time this product is ordered

<sup>2</sup> Available on Mobile Dolly Base, Reversible Footboard and Skis with Half & Full Footrest

<sup>3</sup> Adjustable height push handle codes for high back chairs PH017, PH019, PH021, PH023, PH025; Also available for fixed height (codes PH030 - PH033)

# brookfield

## all optional accessories

	Size 0	Size 1	Size 2	Size 3	Size 4
Lower leg & seat accessories	Code	Code	Code	Code	Code
ski & half footrest	SK007	SK008	SK009	SK010	SK011
ski & full footrest	SK018	SK019	SK020	SK021	SK022
reversible footboard	FB001	FB002	FB003	FB004	FB005
adjustable footrest	FR001	FR002	FR003	FR004	FR004
folding footrest	FR014	FR015	FR016	FR017	FR017
footplate and straps <sup>1</sup>	FP002	FP003	FP004	FP005	FP005
independent adjustable footrest	4187	4187	4187	4187	4187
mobile dolly base	DL001	DL002	DL003	DL004	DL005
kicking board	KB006	KB007	KB008	KB009	KB009
knee blocks	KN001	KN001	KN001	KN001	KN001
minimum raise mobile base		MB001	MB002	MB003	MB004
4 glisdomes complete with screws	GD001	GD001	GD001	GD001	GD001
4 mobile legs with 75mm castors	LG001	LG002	LG003	LG004	LG005
<b>Seat accessories</b>					
pommel	PL013	PL010	PL010	PL012	PL012
<b>Tray accessories</b>					
wooden tray	TR072	TR073	TR074	TR005	TR005
quick release plastic tray	TR102	TR103	TR104		
tray handrail full width	HR001	HR002	HR002	HR003	HR003
tray handrail half width	HR004	HR004	HR004	HR004	HR004
tray with wing cutout		TR008	TR009	TR010	TR010
<b>Back accessories</b>					
strap for lateral wings (buckle fixing)		ST020	ST021	ST022	ST022
strap for lateral wings (velcro fixing)		ST046	ST047	ST048	ST049
25mm spacers to reduced depth. low back #	BK001	BK003	BK005	BK007	BK009
25mm spacers to reduced depth. high back #	BK002	BK004	BK006	BK008	BK010
lumbar pad for moulded back	PD007	PD008	PD009	PD010	PD010
lumbar pad for flat back	PD002	PD003	PD004	PD005	PD005
sacral pad for moulded back	PD018	PD019	PD020	PD021	PD021
sacral pad for flat back	PD013	PD014	PD015	PD016	PD016
backrest extension support	HT006	HT007	HT008	HT010	HT010
headrest fully adjustable	HT001	HT002	HT003	HT005	HT005
<b>Other accessories</b>					
four point harness	HN002	HN003	HN003	HN004	HN004
waistcoat harness - small	HN009	HN009	HN009		
waistcoat harness - medium			HN010	HN010	
waistcoat harness - large				HN011	HN011
groin harness	HN039	HN040	HN040	HN041	HN041
adjustable height push handle (low back)	PH016	PH018	PH020	PH022	PH024
adjustable height push handle (high back)	PH017	PH019	PH021	PH023	PH025
fixed height push handle	PH030	PH031	PH032	PH033	PH033
<b>Cushions</b>					
25mm pelvic cushions (pair)	CS005	CS006	CS007	CS008	CS009
38mm pelvic cushions (pair)	CS014	CS015	CS016	CS017	CS018
50mm pelvic cushions (pair)	CS023	CS024	CS025	CS026	CS027
62mm pelvic cushions (pair)	CS032	CS033	CS034	CS035	CS036
75mm pelvic cushions (pair)	CS041	CS042	CS043	CS044	CS045
25+25mm pelvic cushions (pair)	CS050	CS051	CS052	CS053	CS054
38+25mm pelvic cushions (pair)	CS231	CS232	CS233	CS234	CS235
50+25mm pelvic cushions (pair)	CS077	CS078	CS079	CS080	CS081
62+25mm pelvic cushions (pair)	CS086	CS087	CS088	CS089	CS090
75x50mm pelvic wedge (pair)	CS095	CS096	CS097	CS098	CS099
75x62mm pelvic wedge (pair)	CS104	CS105	CS106	CS107	CS108
75x75mm pelvic wedge (pair)	CS113	CS114	CS115	CS116	CS117
75x100mm pelvic wedge (pair)	CS122	CS123	CS124	CS125	CS126

# Must be factory fitted at the time of order

1 Available on mobile dolly base, reversible footboard and skis with full footrest



Colour Ranges

See page 129 for colour options

“I have always found Smirthwaite to be caring. They care about the needs of my clients, they listen to what I need and they care about providing the child with the very best solution”

Claire, Occupational Therapist  
South West



# corner chair

floor sitter with high levels of adaptability to develop balance as the child grows



## Floor level support

Our Corner Chair is ideal for young children from the age of 8 months who need to develop sitting balance. During floor sitting, some children are inclined to fall back or sideways if they overstretch or lose concentration. The pommel at the front is designed to keep legs abducted to promote a stable posture.

Our Corner Chair is designed to provide support at the back and sides of children to improve their sitting balance. This encourages social interaction and allows them to engage in floor-based activities without the risk of falling over.

## Maximum adjustability

The Corner Chair offers high level of adjustability in the back, side angle, side pad, headrest and pommel. This means that the chair can be positioned to suit your child's individual needs whilst also enabling the chair to easily grow with your child.

Corner Chair can be used at higher level when attached to the Ladder (Codes 4373 - 4375). Please see page 104 for details.

buy online



## Standard key features



Height and width adjustable headrest



Height and angle adjustable support pads



Adjustable pommel & lapstrap



### Optional table tray accessory

Ideal for activity work, feeding or playing

## Corner Chair technical data

all dimensions in mm

Code	Size	Height range	Width	Seat depth	Max. user weight (kg)	Product weight (kg)
5501	1	410-520	400	300	85	10
5502	2	520-660	400	300	85	12
5503	3	550-690	450	350	85	14

## Table tray technical data

all dimensions in mm

Code	Size	Height range	Width	Depth	Product weight (kg)
5521	1	130-280	600	600	8
5523	2	345-545	600	600	10

 Colour Ranges  
See page 129 for colour options

# felix

## Comfortable learning

Standard classroom chairs can be uncomfortable for a whole day of learning but the Felix comes with a clever complete seat and back cushion in one. The cushion gives that little extra padding on the seat and back. When a child is comfortable learning becomes more effective.



the simple, stackable,  
wooden school chair with  
removable covers

## Simple features

The Felix is stackable - an important feature for any classroom at the end of a working day. The cushions are easily removable and wipeable and come in four vibrant colours: sea green, candy, citrus green and cobalt. The cushions can be easily removed, cleaned, replaced and interchanged with other chairs of the same size.

## Classroom chair

The Felix has been designed as an active classroom armchair. The lateral side armrests not only provide support when sitting but they also facilitate the sit to standing movement and vice-versa. The shape of the seat and back promotes good posture and the design of the chair legs provide stability and prevents tipping.



buy online

## Standard key features

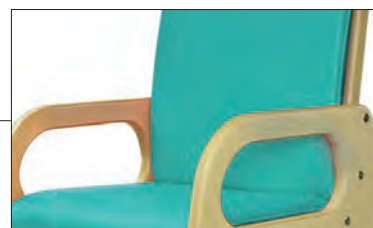

Removable covers



Pelvic strap (optional)



Anti-tip legs

## Felix technical data

all dimensions in mm unless otherwise stated

Size	Seat height	Width	Seat depth	Max user weight (kg)	Product weight (kg)
1	258	290	220	75	6
2	308	330	270	80	8
3	368	370	320	90	10
4	418	410	370	110	12
5	468	450	420	110	14

Colours	Size 1 Codes	Size 2 Codes	Size 3 Codes	Size 4 Codes	Size 5 Codes
sea green	8166	8167	8168	8169	8170
candy	8171	8172	8173	8174	8175
citrus green	8176	8177	8178	8179	8180
cobalt	8181	8182	8183	8184	8185

 Colour Ranges  
See page 129 for colour options

# foxdenton

## Supportive and inclusive

The Foxdenton is a solid classroom chair for children from 3 years old who require minimal levels of postural support when seated. The appearance of the Foxdenton school chair has been purposely created to ensure your child feels more included in the classroom environment.



for school children with  
lower postural needs,  
who want to achieve  
enhanced independence  
within the classroom  
environment

## Adjustable support

Good seating posture starts with stabilising the pelvis. The Foxdenton has simple side supports that can be adjusted to keep your child's pelvis better aligned. A flip-up footrest also enables your child to sit in a more comfortable position.

## Effective learning

Playing, communicating, eating and carrying out desk based activities are essential elements of school life. However, for some children these activities become so much harder when they are seated in a standard classroom chair. The Foxdenton provides support when they need it the most.

## Colours

The following colour options apply.  
No other options are available.

-  Red - size 1
-  Blue - size 2
-  Green - size 3
-  Light blue - size 4
-  Charcoal - size 5

Foxdenton chair comes with adjustable side supports, flip up footrest and pelvic strap



buy online

provides support  
when they need  
it most



Picture shows optional foot straps

## Standard key features



Pelvic strap



Adjustable side supports



Flip-up footrest

## Foxdenton technical data

all dimensions in mm unless otherwise stated

Code	Size	Seat height	Width	Seat depth	Max user weight (kg)	Product weight (kg)
8011	1	270	120-240	255	20	4
8012	2	320	140-260	285	30	4
8013	3	355	180-310	320	45	5
8014	4	380	200-380	375	70	5
8015	5	440	200-380	375	80	6

Optional Accessories	Size 1 Codes	Size 2 Codes	Size 3 Codes	Size 4 Codes	Size 5 Codes
foot straps	ST033	ST033	ST034	ST034	ST034
backrest thickness 40mm	BK137	BK138	BK139	BK140	BK141
backrest thickness 60mm	BK142	BK143	BK144	BK145	BK146

Please note: the Foxdenton size 4 & 5 must be purchased with the footrest.

# hardrock

## Robust and durable

The Hardrock is an extremely durable and robust chair that has been specifically designed for children to young adults who are prone to rock repetitively. The Hardrock provides moderate levels of postural support and is suitable for both school and home environments.

## Tailoring to the child's needs

It can be a challenge to engage children with complex learning difficulties in educational and everyday activities. The Hardrock tackles this issue and offers a positive solution. It provides a safe environment and one that is conducive to learning.



an extremely durable  
chair for children &  
young adults who are  
prone to rock

## Posture matters

The Hardrock uses an anti-thrust system and anterior pad to provide secure postural management within clearly defined boundaries. Thoracic supports and stabilisers are available for children who exhibit sideways motion.

Hardrock pictured with optional accessories; mobile base, extended gables, stabilisers, heel huggies and thoracic supports

secure postural management within  
clearly defined boundaries

## Standard key features



Tray & chest pad

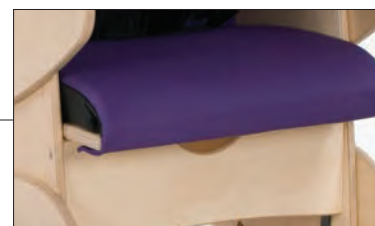

Anti thrust cushions



Pelvic strap



Mobile base and push handle  
standard on size 4 only



Standard Hardrock size 2 & 3 pictured skis, footboard and transporter wheels

## Hardrock technical data

all dimensions in mm unless otherwise stated

Instructional video available online

Code	Size	Seat height	Width	Seat depth	Back height	Max user weight (kg)	Product weight (kg)
8201	1	220-315	290	230-305	300	50	35
8202	2	260-410	350	300-415	390	60	35
8203	3	290-440	430	370-485	470	70	40
8204	4	375-525	470	400-550	575	90	50

Sizes 1, 2 & 3 of the Hardrock chair come complete with adjustable armrests, anti-thrust seat cushion, tray, buckle pelvic strap with pad and transporter base (consists of skis with transporter wheels and integrated footboard).

Size 4 of the Hardrock chair comes complete with adjustable armrests, anti-thrust seat cushion, tray, a buckle pelvic strap with pad and mobile base with push handle.

Colour Ranges  
See page 129 for colour options

# hardrock

## optional accessories



### Padded tray insert (fitted top)<sup>1</sup>

CODE TR035 - TR037

Provides comfort and protection



### Padded tray insert<sup>1</sup>

CODE TR031 - TR033

Provides extra comfort and protection  
Fitted underneath the tray

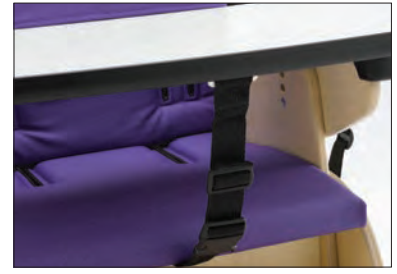

### Front tray retaining strap<sup>1</sup>

CODE ST053

Secures the tray and keeps the tray  
in the desired position



### Rear tray retaining strap<sup>1</sup>

CODE ST054

Secures the tray and keeps the tray  
in the desired position



### Side tray retaining strap<sup>1</sup>

CODE ST055

Secures the tray and keeps the tray  
in the desired position



### Trunk supports with straps<sup>2</sup>

CODE SP010 - SP011

Provides additional trunk support



### Footplate & heel huggies

CODE FP017 - FP019

Provides extra foot support  
Straps and sandals can be added



### Stabilisers<sup>1</sup>

CODE SB001 - SB002

Prevents sideways rocking

### Extended side gables<sup>1</sup>

CODE EG001 - EG002

Keeps child's legs within the chair



### Moulded pelvic support<sup>2</sup>

CODE SP017 - SP019

Provides snug contoured support

1 Must be factory fitted at time the chair is ordered

2 Requires slatted backrest



### 4-point pelvic strap<sup>1</sup>

CODE HN074 - HN076

Firm support to stabilise hip position



### Increased height backrest (extra 100mm)<sup>2</sup>

CODE BK155 - BK157

Provides extra back support for taller children



### Pommel<sup>1</sup>

CODE PL020 - PL021

Encourages hip abduction



### Mobile base with push handle

CODE MB010 - MB012

Enables child to be easily moved whilst seated

Comes as standard for size 4 only



### Footplate & heel bar

CODE FP017 - FP019

Provides extra foot support  
Straps and sandals can be added

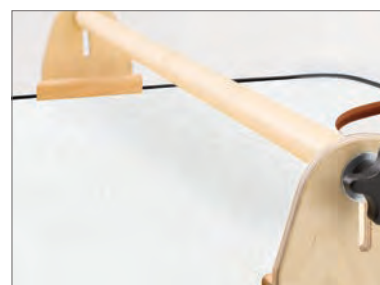

### Tray handrail full width

CODE GB010 - GB012

Helps child to stabilise upper limb  
Additionally can be used to attach toys



### Samba style headrest

CODE HT014 - HT015

Provides extra support for the head  
Can be shaped by adjusting the sides  
Available in sizes 1 & 2

<sup>1</sup> Must be factory fitted at time the chair is ordered

<sup>2</sup> Available with Slatted and Plain backrests

# hardrock

all optional accessories

	Size 1	Size 2	Size 3	Size 4
Lower leg accessories	Code	Code	Code	Code
mobile base with push handle	MB010	MB010	MB012	MB012
footplate & heel huggies	FP016	FP017	FP018	FP019
stabilisers #	SB001	SB001	SB002	SB002
extended side gables #	EG001	EG001	EG002	EG002
Seat accessories				
pommel	PL020	PL020	PL021	PL021
4 point pelvic strap #	HN073	HN074	HN075	HN076
increased height backrest (extra 100mm) #	BK154	BK155	BK156	BK157
Tray accessories #				
tray handrail full width	GB009	GB010	GB011	GB012
padded tray insert (fitted top)	TR034	TR035	TR036	TR037
padded tray insert (fitted underneath)	TR030	TR031	TR032	TR033
front tray retaining strap	ST053	ST053	ST053	ST053
rear tray retaining strap	ST054	ST054	ST054	ST054
side tray retaining strap	ST055	ST055	ST055	ST055
Back & head accessories				
moulded pelvic support	SP016	SP017	SP018	SP019
trunk supports with straps	SP010	SP010	SP011	SP011
samba style headrest size 1	HT014	HT014	HT014	HT014
samba style headrest size 2	HT015	HT015	HT015	HT015
Cushions				
25mm pelvic cushions (pair)	CS138	CS139	CS140	CS141
38mm pelvic cushions (pair)	CS142	CS143	CS144	CS145
50mm pelvic cushions (pair)	CS146	CS147	CS148	CS149
62mm pelvic cushions (pair)	CS150	CS151	CS152	CS153
75mm pelvic cushions (pair)	CS154	CS155	CS156	CS157
25+25mm pelvic cushions (pair)	CS210	CS211	CS212	CS213
38+25mm pelvic cushions (pair)	CS221	CS222	CS223	CS224
50+25mm pelvic cushions (pair)	CS214	CS215	CS216	CS217
62+25mm pelvic cushions (pair)	CS218	CS219	CS220	CS221

# Must be factory fitted at time the chair is ordered

helping children  
shine



# heathfield

## The perfect start

Heathfield is the perfect starter chair for children from 2 years old to young adults who require minimal levels of postural support when seated. Its unobtrusive design means that it fits well into nursery, school and home environments.

## Meeting your child's needs

The Heathfield and its many accessories work in partnership together to provide support and comfort for your child. We recognise that every child is different and the numerous configurations of the Heathfield will ensure that the chair is tailored to your child's needs.



a simple chair with  
lots of answers. A  
favourite at school  
and home

## A natural choice

We believe in wood as a natural material for our chairs. Wood is extremely durable and it holds a contemporary beauty that makes it aesthetically pleasing whilst being environmentally friendly. Our timber comes from sustainable sources and offers thermal properties that make it warm to the touch. Antibacterial agents are added as part of our processing.



Picture shows quick release tray and skis



buy online

## Standard key features



Fixed or adjustable arms



Contoured or flat seat

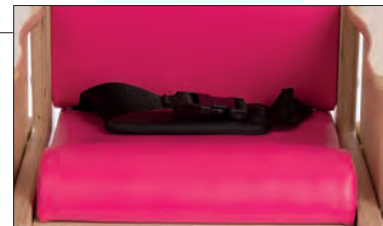

Pelvic lapstrap

## Heathfield technical data

all dimensions in mm unless otherwise stated

Adj Arm Code	Fixed Arm Code	Size	Seat height*	Width	Seat depth	Back height	Max user weight (kg)	Product weight (kg)
6901	6911	1	180-230	240	180-240	250	25	5
6902	6912	2	200-300	280	220-310	280	45	6
6903	6913	3	240-370	325	260-340	320	50	8
6904	6914	4	290-390	365	320-400	365	60	16
6905	6915	5	325-425	435	370-460	420	70	20
6906	6916	6	395-545	435	450-550	420	85	24

The Heathfield chair comes complete with a buckle pelvic strap.

The chair is available with fixed arms or adjustable arms. You can also choose from a contoured or flat seat.

\* Height of chair with contoured seat. The height with a flat seat is 25mm less

 Colour Ranges  
See page 129 for colour options

# heathfield

## optional accessories



### Skis

CODE SK001 - SK006

Provides greater stability



### Reversible footboard

CODE FB006 - FB011

Foot support that prevents unwanted chair movement



### Footplate & straps<sup>1</sup>

CODE FP001 - FP005

Ensures feet are firmly in position



### Mobile dolly base

CODE DL006 - DL011

Enables easy manoeuvrability



### Tray<sup>2</sup>

CODE TR071 - TR074 & TR005

Promotes trunk support and can be used for activities, playing and feeding



### Quick release tray<sup>2</sup>

CODE TR101 - TR104

The tray comes in white and only available on chairs sizes 1-4



### Ski & half footrest

CODE SK012 - SK017

Provides foot support and offers greater stability



### Ski & full footrest

CODE SK023 - SK028

Provides foot support and offers greater stability



### Adjustable footrest

CODE FR005 - FR009

Easy to adjust footrest  
The sides of the footrest help to keep feet within the chair

<sup>1</sup> Available on mobile dolly base, reversible footboard and skis with full footrest

<sup>2</sup> Heathfield chair sizes 1 & 2 must have a suitable stabiliser e.g. footrest/dolly/skis in order to accommodate tray

# heathfield

## optional accessories



### Independent adjustable footrest

CODE 4187

Portable, height and angle adjustable  
Solid support for the feet  
Can be used with a variety of products



### Minimum raise mobile base

CODE MB005 - MB008

Facilities standing transfer  
Easy to move  
Only available with sizes 3 – 6 chairs



### Tray handrail full width

CODE HR001 - HR003

Helps to stabilise upper limbs  
Additionally can be used to attach toys



### Kicking board<sup>1</sup>

CODE KB001 - KB005

Maintains foot position  
Recommended for a child who wraps feet around chair legs



### Knee blocks<sup>2</sup>

CODE KN001

Maintains knee position  
Encourages hip abduction  
Only available with sizes 3 - 6 chairs



### Pommel

CODE PL001 - PL002 or PL013 - PL014

Encourages hip abduction



### Independent adjustable split seat<sup>1</sup>

CODE SE031 - SE034

Accommodates leg length discrepancy  
Only available with sizes 3 – 6 chairs

<sup>1</sup> Must be factory fitted at the time this product is ordered

<sup>2</sup> Available on Mobile dolly base, Reversible footboard and Skis with half & full footrest

<sup>3</sup> Heathfield chair sizes 1 & 2 must have a suitable stabiliser e.g. Footrest/Dolly/Skis in order to accommodate Tray.

# heathfield

## optional accessories

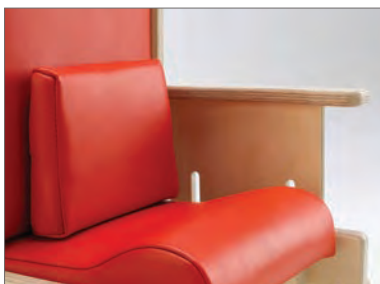

### Lumbar pad

PD001 - PD005

Maintains pelvic position



### Higher backrest in lieu of standard

CODE BK170 - BK174

Provides extra support to the back when required

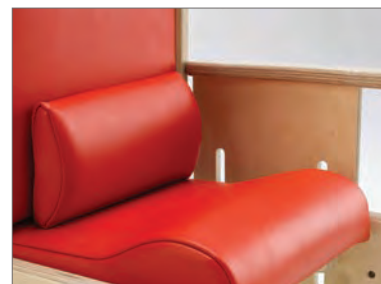

### Sacral pad

CODE PD012 - PD016

Assists in maintaining pelvic position



### Pelvic cushions – double thickness (pair)<sup>1</sup>

CODE CS050 - CS090

Decreases seat width  
Available in various sizes



### Pelvic cushions – single thickness (pair)<sup>2</sup>

CODE CS005 - CS045

Provides hip and thigh support  
Available in various sizes



### Pelvic wedge cushions (pair)<sup>3</sup>

CODE CS095 - CS126

Provides additional support  
Available in various sizes



### Adjustable height push handle

(also available in fixed height\*)<sup>4</sup>

CODE PH010 - PH015

\*CODE PH004 - PH009

Adjusts to achieve optimum push position. To be used in conjunction with a Mobile dolly base or Minimum raise mobile base



### 4 glisdomes

CODE GD001

(pictured on Brookfield)

Comes complete with screws to fix under chair leg

1 Available in sizes 25+25mm, 38+25mm, 50+25mm & 62+25mm, for adjustable arms only

2 Available in size 25mm, 38mm, 50mm, 62mm & 75mm, for adjustable arms only

3 Available in sizes 75x50mm, 75x62mm, 75x75mm, 100x75mm, for adjustable arms only

4 Suitable only for Heathfield ordered with adjustable arms

# heathfield

## all optional accessories

	Size 1	Size 2	Size 3	Size 4	Size 5	Size 6
Lower leg & seat accessories	Code	Code	Code	Code	Code	Code
skis	SK001	SK002	SK003	SK004	SK005	SK006
ski & half footrest	SK012	SK013	SK014	SK015	SK016	SK017
ski & full footrest	SK023	SK024	SK025	SK026	SK027	SK028
reversible footboard	FB006	FB007	FB008	FB009	FB010	FB011
adjustable footrest	FR005	FR006	FR007	FR008	FR009	FR009
independent adjustable footrest	4187	4187	4187	4187	4187	4187
kicking board	KB001	KB002	KB003	KB004	KB005	KB005
mobile dolly base	DL006	DL007	DL008	DL009	DL010	DL011
minimum raise mobile base			MB005	MB006	MB007	MB008
footplate and straps <sup>1</sup>	FP001	FP002	FP003	FP004	FP005	FP005
knee blocks	KN001	KN001	KN001	KN001		
pommel	PL001	PL002	PL013	PL014	PL014	PL014
independent adjustable split seat #			SE031	SE032	SE033	SE034
4 glisdomes complete with screws	GD001	GD001	GD001	GD001	GD001	GD001
<b>Tray accessories</b>						
quick release tray	TR101	TR102	TR103	TR104		
wooden tray	TR071	TR072	TR073	TR074	TR005	TR005
tray handrail full width	HR001	HR001	HR002	HR002	HR003	HR003
tray handrail half width	HR004	HR004	HR004	HR004	HR004	HR004
<b>Back accessories</b>						
higher backrest in lieu of standard #	BK170	BK171	BK172	BK173	BK174	BK174
<b>Cushions (for adjustable arm chairs only)</b>						
25mm pelvic cushions (pair)	CS005	CS005	CS006	CS007	CS008	CS009
38mm pelvic cushions (pair)	CS014	CS014	CS015	CS016	CS017	CS018
50mm pelvic cushions (pair)	CS023	CS023	CS024	CS025	CS026	CS027
62mm pelvic cushions (pair)	CS032	CS032	CS033	CS034	CS035	CS036
75mm pelvic cushions (pair)	CS041	CS041	CS042	CS043	CS044	CS045
25 + 25mm pelvic cushion (pair)	CS050	CS050	CS051	CS052	CS053	CS05
38 + 25mm pelvic cushion (pair)	CS230	CS231	CS232	CS233	CS234	CS235
50 + 25mm pelvic cushion (pair)	CS077	CS077	CS078	CS079	CS080	CS081
62 + 25mm pelvic cushion (pair)	CS086	CS086	CS087	CS088	CS089	CS090
75 + 50mm pelvic wedge cushion (pair)	CS095	CS095	CS096	CS097	CS098	CS099
75 + 62mm pelvic wedge cushion (pair)	CS104	CS104	CS105	CS106	CS107	CS108
75 + 75mm pelvic wedge cushion (pair)	CS113	CS113	CS114	CS115	CS116	CS117
75 + 100mm pelvic wedge cushions (pair)	CS122	CS122	CS123	CS124	CS125	CS126
<b>Other accessories</b>						
groin harness	HN039	HN039	HN040	HN040	HN041	HN041
four point harness	HN001	HN002	HN003	HN003	HN004	HN004
waistcoat harness	HN009	HN009	HN010	HN010	HN011	HN011
adjustable height push handle	PH010	PH011	PH012	PH013	PH014	PH015
fixed height push handle	PH004	PH005	PH006	PH007	PH008	PH009

# Must be factory fitted at the time of order

1 Available on mobile dolly base, reversible footboard and skis with full footrest

# hip spica

## Support and comfort

Our range of Hip Spica chairs has been specifically designed for children from the age of 8 months old who are in plaster casts following hip surgery and require supportive seating.

## Multi-Adjustable Hip Spica chair

This chair is available in three sizes and is ideal for children from 18 months old to young adults. It is designed for children using leg abduction splints. The front section of the chair has a storage area and easily separates from the seat for access. The back also fully reclines to achieve a more comfortable position. The chair comes complete with pelvic strap, shoulder harness and tray.

## Portable Hip Spica chair

The Portable Hip Spica features a new slimline design and can easily be dismantled so that it is simple to transport. Suitable for children aged from eight months to three years old. It is supplied with a 5-point harness and quick release tray as standard.

**Rental scheme is available, contact us for details.**



for children in  
hip spica casts helping  
to make life easier

Multi-adjustable Hip Spica chair



## STEPS Hip Spica chair

This chair has been designed in collaboration with STEPS. STEPS is a national charity supporting children affected by clubfoot, hip dysplasia and other lower limb conditions.

The chair comes complete with pelvic strap, shoulder harness and tray. Shown on page 31.

## Standard Colours

-  Rouge
-  Ocean blue



buy online

## Standard key features



STEPS Hip Spica chair



STEPS harness



Tray (shown on STEPS)



Multi-adjustable detachable tray section



Portable Hip Plaster seat area

### Multi-Adjustable Hip Spica chair technical data

all dimensions in mm

Code	Size	Length	Seat height	Back height	Tray size	Max user weight (kg)	Product weight (kg)
5585	1	1000	400-560	370-660	760 x 600	85	80
5586	2	1000	400-560	450-750	760 x 600	85	81
5587	3	1000	400-560	550-850	760 x 600	85	82

■ Instructional video available online

### STEPS Hip Spica chair technical data

all dimensions in mm

Code	Size	Length	Seat height	Back height	Tray size	Max user weight (kg)	Product weight (kg)
5580	1	800	410-510	300-400	650 x 600	85	78

### Portable Hip Spica chair technical data

all dimensions in mm

Code	Size	Seat height	Width	Footprint	Tray size	Max user weight (kg)	Product weight (kg)
5596	1	210-360	210-360	560 x 660	550 x 440	25	10

# indiGO

buy online

## Social integration

IndiGO is a smart and stylish chair, ideal for use by teenagers both at school and at home. While delivering the necessary comfort and postural support through its discreet built-in thoracics and lumbar prompt, the chair is also designed to integrate seamlessly into any classroom environment.

## Promoting independence

IndiGO has been designed for teenagers with mild to moderate postural needs, who want to achieve enhanced independence from their chair. The user operated brake, for instance, puts the user in control of applying and releasing the brakes without needing assistance instantly giving them a sense of independence.

The brake can be fitted on either the left hand or right hand side.

## Customisable solution

IndiGO is customisable, in either black or blue and either size 4 or size 5, to the needs of the user. For children with moderate needs, we offer a range of accessories that promote correct seating posture. A full range of accessories can be found on page 34-35. The chair has been designed with both the therapist's and the child's needs in mind. All adjustments can be made easily and mostly without tools.

for older children in  
school or college

designed for  
teenagers with mild  
to moderate postural  
needs, who want to  
achieve enhanced  
independence

## Choice of base and back

IndiGO now has the option of an electric hi-lo base (as pictured below and right), making height adjustments simple and easy.

IndiGO has two available back sizes: a low back and a high back. The low back has been designed with social integration in mind and is best suited to a child with mild needs. The high back is more appropriate for a child who may need a harness or extra physical support.

### New Feature!

The indiGo is now  
available on an  
electric hi-lo base

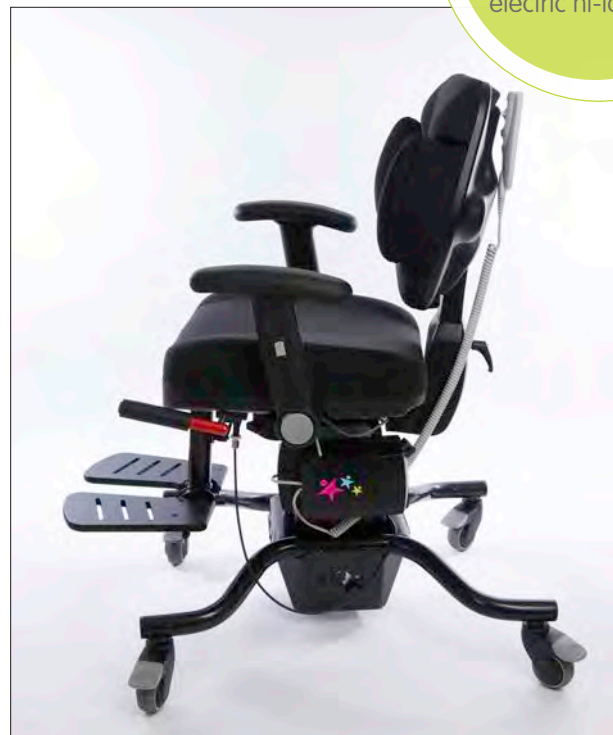

Pictured: indiGO on an optional electric hi-lo base with a flip-up footrest





Pictured: an indiGO on an optional electric hi-lo base with a flip-up footrest

## Standard key features

### Lumbar support

IndiGO's adjustable lumbar prompt allows the therapist to change the shape of the seat back in this region and provide a more comfortable position for the user.

### Flip away armrest

The armrests are height adjustable and can also flip away when they are not needed. This is particularly beneficial when self-transferring from one chair to another.

### Contoured seat

The keystone to posture management is the pelvis and IndiGO's contoured seat helps to ensure that it is correctly positioned.

### Thoracic support

The thoracic supports are adjustable, with an allen key, to give the user just the amount of support they need. The lumbar is the region of the spine between the diaphragm and the pelvis, which supports the most body weight and is the most flexible.

## indiGO technical data

all dimensions in mm unless otherwise stated / see following page for chair product codes

Measurement	Size 4	Size 5	Size 6
Seat height from floor	490 - 650	490 - 650	490 - 650
Seat height from floor (hi-lo base)	510 - 760	510 - 760	510 - 760
Seat depth	340 - 420	390 - 470	440 - 520
Seat width	440	490	490
Seat angle (prone - supine)	87 - 100	87 - 100	87 - 100
Back angle (prone - supine)	90 - 105	90 - 105	90 - 105
Low back height	420 - 500	420 - 500	420 - 500
High back height	560 - 640	560 - 640	560 - 640
Headrest height from top of the backrest	100 - 200	100 - 200	100 - 200
Armrest height	190 - 250	190 - 250	190 - 250
Seat to footrest	340 - 490	340 - 490	340 - 490
Footprint	900 x 740	900 x 740	900 x 740
Max user weight (kg)	100	100	100
Product weight (kg)	27	30	30

	Size 4 product codes	Size 5 product codes	Size 6 product codes
standard seat & low back - black	11114	11115	11116
standard seat & low back - blue	11124	11125	11126
standard seat & high back - black	11214	11215	11216
standard seat & high back - blue	11224	11225	11226
standard seat & low back - black hi-lo	11134	11135	11136
standard seat & low back - blue hi-lo	11234	11235	11236
standard seat & high back - black hi-lo	11144	11145	11146
standard seat & high back - blue hi-lo	11244	11245	11246

# indiGO

## optional accessories



### Flip-up footrest

CODE FR055

Flips up independently

Height adjustable



### Flat headrest

CODE HT026

Provides extra head support

Height, angle, depth adjustable



### Multi-grip headrest

CODE HT027

Can be shaped by adjusting the sides

Height, angle, depth adjustable



### Pommel

CODE PL035

Encourages hip abduction



# indiGO

## all optional accessories

Accessories	Size 4 Code	Size 5 Code	Size 6 Code
flip-up footrest	FR055	FR055	FR055
pommel	PL035	PL035	PL035
flat headrest	HT026	HT026	HT026
multi-grip headrest	HT027	HT027	HT027
indiGO teenage harness *	HN243	HN243	HN243
indiGO teenage harness with the zip *	HN244	HN244	HN244

\*high back only

Office Version indiGO	Size 4 Code	Size 5 Code	Size 6 Code
office version low back	12114	12115	12116
office version high back	12214	12215	12216

indiGO comes with two options of back; you can choose from a high or a low back. indiGO comes complete with pelvic lap strap, flip away armrests and user operated brakes. You can also choose from two colours: black or blue.



# juni

 buy online

## Numerous benefits

Whether in the classroom, nursery, or at home, better posture whilst seated creates a more positive experience for your child; fine motor skills develop, confidence increases and the ability to engage and learn becomes easier.

The Juni comes in three vibrant colours and the contemporary appeal helps to promote social inclusion.

## Posture at its foundation

Juni's seat and backrest both provide unique contouring. This promotes better posture, gives higher levels of comfort and helps your child feel more secure and stable in the Juni. It is our vibrant chair for children who require minimal levels of postural support when seated.

## Highly adjustable

We understand that your child's needs change during each stage of growth and development. Seat height and depth as well as armrest height can all be easily adjusted. The backrest can be reclined by 5° increments (from 95° to 105°), whilst it also features an unique built-in lumbar support.

our vibrant chair  
providing unique  
contouring, for mild  
to moderate postural  
support from 18mths old

high levels  
of comfort





## Standard key features



Angle adjustable back rest



Adjustable lumbar support



Easy leg adjustments



Lap strap

## Juni technical data

all dimensions in mm unless otherwise stated

Size	1	2	3	4
Height	160-220	200-280	240-340	300-400
Width	240	280	325	365
Depth	180-240	220-300	260-360	320-420
Back height	260	290	325	400
Back angle (°)	95/100/105	95/100/105	95/100/105	95/100/105
Max user weight (kg)	30	40	50	60
Product weight (kg)	4	6	8	10
Colour options	Codes			
Red	16011	16012	16013	16014
Lime	16021	16022	16023	16024
Blue	16031	16032	16033	16034

■ Instructional video available online

The Junii chair comes with contoured seat and backrest, built-in lumbar support, pelvic lap strap, height and depth adjustable seat, height adjustable armrests as well as angle adjustable backrest as standard.

# juni

## optional accessories



### Skis

CODE SK101 - SK104

Helps to stabilise and prevent chair movements



### Ski & footboard<sup>1</sup>

CODE SK111 - SK114

Provides foot support and offers greater stability



### Mobile skis

CODE DL101 - DL104

Gives clearance to facilitate standing transfer



### Sliding footrest<sup>2</sup>

CODE DL111 - DL114

Provides foot support  
Slides backwards to give clearance to facilitate standing transfer

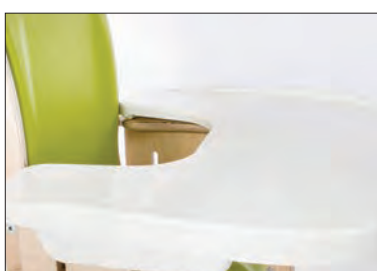

### Quick release tray

Patent applied for

CODE TR101 - TR104

The tray is available in white



### Height adjustable push handle

CODE PH101 - PH104

Adjusts to achieve optimum push position



### Side support cushions<sup>3</sup>

Provides hip and thigh support  
Available in 25mm and 50mm



### Footrest

CODE FR051 - FR054

Available in 4 sizes



### 4-point harness<sup>3</sup>

Provides trunk support  
Available in 3 colours & 4 sizes



### Pommel

Code PL111 - PL132

Encourages hip abduction

<sup>1</sup> Raisers are also available in either 12mm (CODE: RA049 - RA052) or 24mm (CODE: RA045 - RA048)

<sup>2</sup> Sliding footrest can only be used in conjunction with the mobile skis

<sup>3</sup> Codes vary depending on the colour and size; please contact us directly or see our price list for all codes

# juni

## all optional accessories

Lower leg & seat accessories	Size 1 Code	Size 2 Code	Size 3 Code	Size 4 Code
skis	SK101	SK102	SK103	SK104
mobile skis	DL101	DL102	DL103	DL104
skis & footboard	SK111	SK112	SK113	SK114
sliding footrest (for use with mobile skis)	DL111	DL112	DL113	DL114
height adjustable push handle	PH101	PH102	PH103	PH104
juni footrest	FR051	FR052	FR053	FR054
juni extended outriggers	LG153	LG154	LG155	
pommel - red	PL111	PL111	PL111	PL112
pommel - lime	PL121	PL121	PL121	PL122
pommel - blue	PL131	PL131	PL131	PL132
<b>Tray accessories</b>				
quick release tray	TR101	TR102	TR103	TR104
<b>Cushions</b>				
25mm side support cushions - red	CS511	CS511	CS512	CS512
25mm side support cushions - lime	CS521	CS521	CS522	CS522
25mm side support cushions - blue	CS531	CS531	CS532	CS532
50mm side support cushions - red	CS611	CS611	CS612	CS612
50mm side support cushions - lime	CS621	CS621	CS622	CS622
50mm side support cushions - blue	CS631	CS631	CS632	CS632
25mm + 25mm double cushions - red	JC001	JC001	JC004	JC004
25mm + 25mm double cushions - lime	JC002	JC002	JC005	JC005
25mm + 25mm double cushions - blue	JC003	JC003	JC006	JC006
50mm + 25mm double cushions - red	JC051	JC051	JC054	JC054
50mm + 25mm double cushions - lime	JC052	JC052	JC055	JC055
50mm + 25mm double cushions - blue	JC053	JC053	JC056	JC056
<b>Other accessories</b>				
4 point harness - red	HN211	HN212	HN213	HN214
4 point harness - lime	HN221	HN222	HN223	HN224
4 point harness - blue	HN231	HN232	HN233	HN234

# new!

## Dolly Base

CODE PH101 - PH104

Facilitates manoeuvrability of your Juni chair

Available in 4 sizes



Smirthwaite's mobile base for your Juni, opens up a whole new world.

- Manoeuvre from class to class or around the home.
- Slimline and easy to use.
- Hard wearing wheels.
- Compliments the style of your Juni.

 Colour Ranges  
See page 129 for colour options

# juni extras

We work in close collaboration with therapists, parents and children to ensure that our products meet and surpass your expectations. Through your valuable feedback the Juni also has the following optional extras: highly adjustable Juni Table, Juni Hi & Lo Boosters and Juni Hi Lo Base to overcome height issues at home, nursery & school. See all Juni accessories on pages 38 and 39.

Juni extras to help overcome height issues at home, nursery & school

## Juni Hi Lo Base

We understand the challenges of the classroom and home environment. Height adjustment is now easy with our Juni Hi Lo Base using the gas assisted lift. The slimline footprint of the base makes this the ideal solution to fit under most classroom desks. So now, you can use your Juni chair together with the Juni Hi Lo Base by simply attaching it to the plate on top of the base; or use the chair independently where height adjustments are not needed.

Only suitable for Juni chairs size 1 & 2.



## Juni Hi Lo Base technical data

all dimensions in mm unless otherwise stated

Size of Juni	1	2
Seat height from floor	160 - 570	200 - 570
Lower leg length to footrest	160 - 220	200 - 280
Push handle height	500 - 1000	500 - 1000
Base length and width	650 x 520	650 x 520
Max user weight (kg)	30kg	40kg
Product weight (kg)	10.5kg	10.5kg

Colour	1	2
Red footrest	HL111	HL112
Lime footrest	HL121	HL122
Blue footrest	HL131	HL132
Natural footrest	HL141	HL142

 Colour Ranges  
See page 129 for colour options



# juni extras

## Juni Table

The Juni table offers two key benefits; the legs are adjustable so your child can work or play at the correct height and the table folds, which allows for easy storage. Available in a variety of colours this is the perfect companion to your favourite Juni chair.



## Juni table technical data

all dimensions in mm unless otherwise stated

Size	1	2
Height	310-450	400-600
Width	700	780
Depth	530	590
Max weight (kg)	60	60
Product weight (kg)	8	10

Colour	Code	
Red top	2411	2412
Lime top	2421	2422
Blue top	2431	2432
Natural top	2441	2442



## Juni Boosters

Our Hi Booster is perfect for the breakfast bar or for feeding your child without crouching or kneeling. Our Lo Booster allows for sitting your child at the dinner table or giving your child extra height.

Hi & Lo Boosters come complete with a black 5-point harness and are also available with castors\*. The Juni Boosters accommodate Juni chair size 1 and 2 only. Please visit our websites for more details.

## Juni Boosters technical data

all dimensions in mm unless otherwise stated

Booster Type	Lo Booster	Hi Booster
Size of chair on booster	1 & 2	1 & 2
Seat height	670-770	870-970
Footprint open	520 x 520	520 x 640
Folded size	520 x 340 x 700	520 x 420 x 930
Max user weight (kg)	40	40
Product weight (kg)	7	8

Colour	Codes			
	Size 1	Size 2	Size 1	Size 2
Red	JB111	JB121	JB112	JB122
Lime	JB211	JB221	JB212	JB222
Blue	JB311	JB321	JB312	JB322
Natural	JB411	JB421	JB412	JB422

# sam

## Facilitating postural ability

The SAM maintains and controls a symmetrical postural alignment in a stable forward leaning position. Stability is given to all body segments, starting with the pelvis as the 'keystone' of the structure.



## Preventing complications

Contractures, deformity and localised high pressures are frequently associated with the inability to sit independently. The SAM assists in the prevention of these complications by giving the appropriate support and control to the body system. A child presenting with one or more of the following is suitable for the SAM system; sitting ability level 2 - 4 PPAS, athetoid movements, extensor thrust, spasticity, hypotonia or poor head control.

designed for a child  
with little or no ability  
to sit independently.  
Modular and highly  
customisable

## Designed by Therapists

30 years of research, clinical trials and evolution have culminated in the development of this unique seating system. A key part of the system is the forward tilting contoured seat. The 'straddle' not 'saddle' seat encourages anterior tilt of the pelvis to facilitate postural ability and to enhance function and cognitive development.

## Forward leaning

The forward lean position is one, which has been advocated by many clinical professionals both for the able bodied, and the non-ambulant as that which promotes functional ability. It is the usual position adopted by the able-bodied person when attention to accuracy and efficiency of action is called for.

**Sam is made up by purchasing one of each of the below 1-6 making it highly customisable.**

Components	Size 1 Code	Size 2 Code	Size 3 Code	Size 4 Code
1. anterior support	SP012	SP013	SP014	SP015
2. work tray	TR012	TR012	TR012	TR012
3. push handle	PH001	PH001	PH001	PH001
4. H frame	HF001	HF002	HF003	HF004
5. contoured seat	SS001	SS002	SS003	SS004
6. mobile base	MB013	MB013	MB013	MB013

SAM chair comes with all of the above as standard.

Accessories	Size 1 Code	Size 2 Code	Size 3 Code	Size 4 Code
shoulder harness	HN019	HN020	HN021	HN022
tray foam wedge	FM016	FM016	FM016	FM016

## Standard key features



Anterior support



Durable tray



Contoured 'straddle' seat & strap



Mobile base

### SAM technical data

all dimensions in mm unless otherwise stated

Size	1	2	3	4
Code	8511	8512	8513	8514
Seat depth	200	230	280	330
Seat width	250	290	370	420
Seat height (with H frame)	280 - 350	280 - 350	280 - 400	300 - 480
Anterior supports (length)	165	195	225	265
Anterior supports (width)	140 - 180	180 - 210	220 - 280	280 - 340
Footboard height from floor	55	55	55	55
Ground clearance	40	40	40	40
Total length inc. tray & handle	920	920	920	920
Width	650	650	650	650
Max user weight (kg) (Re: seat size)	50	60	70	80
Product weight (kg)	39	43	48	52

 Colour Ranges  
See page 129 for colour options

# samba

## Tailored to special needs

The Samba is a versatile chair; it can cater for a wide array of conditions (from mild to complex) and can have as much or as little posture support as required by your child.

When sitting a child in our chairs we always start at the foundation, this is the pelvis. The Samba's 4-point pelvic strap is a key feature, as it allows us to anchor the pelvis in the correct anterior tilted seated position, this can help with preventing sacral sitting and is so easy to adjust.

## Promoting postural control

If your child needs a high level of postural control we may recommend the soft cross harness. This harness promotes spine control by stabilising the shoulders, instead of the more traditional approach of using conventional laterals. For greater alignment support the Soft Cross harness can be used in conjunction with the 4-point pelvic strap.

## A multi-height solution

The Samba provides an impressive seat height range of 295mm. The seat height ranges from 310mm – 605mm, this makes it an ideal solution for children that study, play and live in a multi-height environment.

a versatile seating system with a unique midline support, suitable for mild to complex conditions



**New Feature!**  
The Samba is now available on an electric hi-lo base

## Understanding posture

The Samba has an unique approach to managing posture. It does this effectively by using the contours of the seat and backrest, as opposed to hard intervention. The contouring can be tailored to the needs of your child by adding or taking away the foam inserts. The contours in the backrest have a subtle, but effective way of holding your child in a good mid-line position, without the intervention of using fixed laterals.



 Colour Ranges  
See page 129 for colour options

## Tilt in space

If your child needs to be hoisted, the Samba can be tilted back, this is to enable a safe and controlled transfer, even if your child extends.

The tilt in space is easy to operate by using the safety catch and the lever.



## Standard key features



Controlled tilt



4 point pelvic strap



Contoured seat



Height adjustable footrest & sandals

## Colours

The Samba is now available in our Moxxa range. See page 129 for further details.

## Samba technical data

all dimensions in mm unless otherwise stated

Size	1	2	3	4
Code	8801	8802	8803	8804
Tilt in space (°)	12 - 25	12 - 25	12 - 25	12 - 25
Seat height	310 - 605	310 - 605	310 - 605	310 - 605
Seat depth	180 - 280	245 - 340	300 - 400	375 - 500
Seat width	300	340	340	390
Lower leg length to footrest	150 - 170	200 - 250	255 - 335	310 - 460
Back angle (°)	6 - 18	6 - 18	6 - 18	6 - 18
Back height	360 - 400	420 - 460	470 - 540	480 - 560
Armrest height <sup>1</sup>	510 - 880	510 - 880	510 - 880	510 - 880
Armrest angle (°)	39	39	39	39
Armrest height adjustment	90	90	9-	90
Overall chair height <sup>2</sup>	670 - 1005	740 - 1060	790 - 1110	910 - 1240
Base length and width	650 x 510	650 x 510	650 x 510	650 x 510
Tray size	580 x 530	625 x 530	625 x 530	675 x 585
Max user weight (kg)	80	80	80	80
Product weight (kg)	31	34	35	38

1 Measured from the floor

2 Measured from the floor to the top edge of the chair back

# samba

## optional accessories



### Soft cross harness

CODE HN056 - HN059



### Shoulder harness

CODE HN027 - HN030

Must be used with the mid line support (sheepskin pad removed to connect to harness)



### Elbow protectors

CODE EL001

Assists in maintaining elbows in a forward position



### Mid line support harness

CODE HN023 - HN026

Comes with sheepskin pad

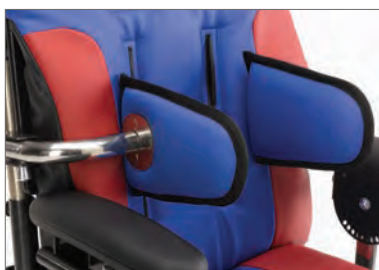

### Swing away lateral supports (pair)<sup>1</sup>

CODE HN061 - HN064 (fixed)

CODE HN065 - HN068 (flexi)

Provides extra trunk support



### Thigh guides<sup>1</sup>

CODE TG004 - TG005

Provides thigh and hip support



### Samba style headrest

CODE HT014 - HT015

Provides extra head support  
Can be shaped by adjusting the sides  
Available in 2 sizes



### Rumba style headrest

CODE HT016 - HT017

Provides extra head support  
Available in 2 sizes



### Flip up footrest<sup>1</sup>

CODE FP025 - FP027

Provides foot support and flips up to give clearance for standing transfer  
Available for sizes 2, 3 and 4

<sup>1</sup> Must be factory fitted at the time this product is ordered

# samba

## all optional accessories

	Size 1 Code	Size 2 Code	Size 3 Code	Size 4 Code
<b>Lower leg &amp; seat accessories</b>				
flip up footrest #		FP025	FP026	FP027
thigh guides	TG004	TG004	TG005	TG005
pommel size 1	PL005	PL005	PL005	PL005
pommel size 2	PL006	PL006	PL006	PL006
elbow protractors	EL001	EL001	EL001	EL001
<b>Tray accessories</b>				
suspension rail	SR003	SR004	SR004	SR005
tray grab rail full width	GB004	GB005	GB005	GB006
<b>Back accessories</b>				
high back	BK148	BK149	BK150	BK151
rigid swing away lateral supports (pair)	HN061	HN062	HN063	HN064
flexi swing away lateral supports (pair)	HN065	HN066	HN067	HN068
soft cross harness	HN056	HN057	HN058	HN059
shoulder harness for the mid-line harness	HN027	HN028	HN029	HN030
mid-line support harness with sheepskin pad	HN023	HN024	HN025	HN026
<b>Head supports/accessories</b>				
whitmyer pro series interface plate	WM001	WM001	WM001	WM001
samba headrest size 1	HT014	HT014	HT014	HT014
samba headrest size 2	HT015	HT015	HT015	HT015
rumba style headrest size 1	HT016	HT016	HT016	HT016
rumba style headrest size 2	HT017	HT017	HT017	HT017

The powered Samba chair comes with 5-piece foam roll kit, 4-point midline pelvic strap, tray, ferndale style sandals, footrest and powered hi-low chassis.

# Must be factory fitted at the time product is ordered



# strato

## Meeting your child's needs

Every child is different. Strato provides maximum adjustability to meet both the needs of the child and the education environment. Strato's seat, lumbar prompt, armrests and footrest, all provides a wide range of adjustments without the need for tools e.g. the gas assisted height adjustment.

The chair also has an easy to read adjustment indicator to record user settings.

## Space Saving

Strato has been designed with a slim line footprint to ensure it slides neatly under desks and tables. You will be amazed at how much space you can save both in the class and at home.

## Taking a different angle

Strato is an innovative classroom chair designed for children and young people from 2 years to young adults who are able to get in and out of their chair independently, but require minimal to moderate postural support when seated.

## Strato seat

The uniquely contoured seat tilts forward to encourage anterior tilt of the pelvis for improved hip stability as well as trunk and lower limb alignment. The design based on the concept of 'straddle' not 'saddle', also aims to enhance function and cognitive development.

"Strato promotes a secure and stable forward leaning functional posture with an extended rather than flexed spine."

Pauline M Pope FCSP MSc BA SRP

**New Feature!**  
The Strato is now available on an electric hi-lo base



Pictured: child using a Strato on the new electric hi-lo base





## Standard key features



Picture shows size 2 in fizzy lime



Pelvic strap



Contoured tilting seat



Height adjustable footrest  
Size 1 & 2 only



Personal pocket

### Colours

The standard base is available in the following colour options:

- Fizzy Lime - sizes 1 & 2
- Black - sizes +2, -3, 3, 4 & 5

The seat is now available in the Dartex fabric range:

- Lime
- Red
- Blue
- Black



### Strato Technical data

all dimensions in mm unless otherwise stated

Size	1	2	+2	-3	3	4	5
Code (standard)	10041	10042	10243	10343	10043	10044	10045
Electric hi-lo	N/A	N/A	N/A	N/A	10143	10144	10145
Seat depth	220	260	260	300	300	350	400
Seat width	250	290	290	370	370	420	450
Seat height	270 - 400	270 - 400	335 - 435	335 - 435	385 - 525	385 - 525	465 - 635
Seat height (on electric hi-lo)	N/A	N/A	N/A	N/A	410 - 658	410 - 658	410 - 658
Seat angle (°)	0-15	0-15	0-15	0-15	0-15	0-15	0-15
Distance between arms	240 - 300	300 - 360	300 - 360	370 - 470	370 - 470	420 - 550	440 - 550
Arm rest height	120 - 160	120 - 160	120 - 160	170 - 230	170 - 230	170 - 230	170 - 230
Arm rest angle (°)	+12 to -12	+12 to -12	+12 to -12	+12 to -12	+12 to -12	+12 to -12	+12 to -12
Seat to footrest height	180 - 280	180 - 280	270 - 350	270 - 350	270 - 350	330 - 420	400 - 500
Footprint	w400 - l490	w400 - l490	w550 - l650	w550 - l650	w550 - l650	w550 - l650	w670 - l660
Max user weight (kg)	40	40	80	80	80	80	90
Product weight (kg)	13	13.5	21.5	21.5	21.5	22	23

Instructional video available online

# strato

## optional accessories



### Footrest

(only for sizes 1 & 2)

CODE FR042

Provides additional foot support



### Flip up footrest

(only for sizes +2, -3, 3, 4 & 5)

CODE FR043, FR144 - FR145

Flips up to give clearance to facilitate standing transfer



### 4-point pelvic dynamic strap

CODE ST050 - ST052

Maintains hip position  
Front dual pull



### Thigh guides

CODE TG006 - TG008

Provides thigh and hip support



### Back with laterals

CODE BK301 - BK302

Provides trunk support



### Adjustable armrests (pair)

CODE AR001 - AR002

Height and angle adjustable



### Personal pocket

CODE MY001

Ideal for storing small items



### Extension handle<sup>1</sup>

(only for sizes 1 & 2)

CODE PH027

Perfect for pushing the chair  
Flips down when not required



### Handy hooks

CODE MY002

Ideal for hanging small items

# strato

## all optional accessories

Accessories	Size 1 Code	Size 2 Code	Size 3 Code	Size 4 Code	Size 5 Code
user operated brakes #			UOB001	UOB001	UOB001
footrest	FR042	FR042	FR043	FR144	FR145
4 point pelvic dynamic strap	ST050	ST050	ST051	ST051	ST052
thigh guides	TG006	TG006	TG007	TG007	TG008
back with laterals	BK301	BK301	BK302	BK302	BK302
adjustable armrests (pair)	AR001	AR001	AR002	AR002	AR002
personal pocket	MY001	MY001	MY001	MY001	MY001
extension handle	PH027	PH027			
handy hooks	MY002	MY002	MY002	MY002	MY002
non tamper kit	AT001	AT001	AT002	AT002	AT002

Strato comes with pelvic strap, adjustable armrest and footrest. Sizes 1 & 2 come with additional handy hook, extension handle, personal pocket and fixed front castors as standard. Sizes 1 & 2 are available in fizzy lime and sizes +2, -3, 3, 4, 5 are available in black.

# Must be factory fitted at the time the chair is ordered.

**New Feature!**  
The Strato is now available on an electric hi-lo base



# sunni

## School canteen chair

Sunni is all about inclusion at meal times at home and school. It gives children the opportunity to eat and socialise with their family and friends instead of eating separately in their own chairs.

## Working with Cerebra

It has been designed along side the Charity Cerebra. Families with a child who has a brain condition face challenges every day. Just to learn, play, make friends, enjoy and experience the world can feel difficult, sometimes impossible. But we believe challenges can be over come.

Cerebra's vision is that every family that includes a child with a brain condition will have the chance to discover a better life together.

Their mission is to listen to families that include children with brain conditions. They use what they tell them to inspire the best research and innovation. Cerebra helps them put the knowledge into practice so they can discover a better life together.



Pictured:  
Sunni with footrest



Lunchtime inclusion  
is very important for a  
child's social interactions  
with friends.

## Benefits of Sunni

- Designed to fit most canteen chairs
- Armrests fold away
- Three point harness
- Wipe clean seat pads
- High backrest for taller children
- Easy to transport and manoeuvre
- Can be used at home and in school
- Available in four vibrant colours

## Optional footrest

An optional footrest is available to give support to the legs when sitting at the table.



Pictured:  
Sunni with tray

buy online

## Standard key features Sunni



Quick foldaway arms



3 Point harness

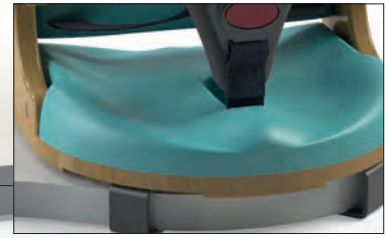

32mm Padded seat

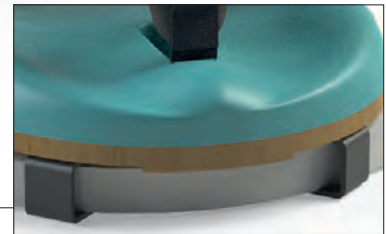

Easy to fix brackets

### Sunni technical data

all dimensions in mm unless otherwise stated

Size	1	1 HB	2	2HB
Seat depth	210	210	258	258
Seat width	226	226	276	276
Back height	253	353	283	408
Armrest height	150	150	175	175
Back angle (°)	96	96	96	96
Max user weight (kg)	15	15	25	25
Product weight (kg)	3	3.5	4	4.5

### Colours



# zoomi/+

## Perfectly customisable

With multiple options to cater for a variety of users, Zoomi can be uniquely configured to meet the needs of your child. We have put together 2 simple options:

- Standard Zoomi
- Zoomi +

## Our standard Zoomi

The standard Zoomi is ideally suited to the classroom and home. Both the seat and footrest can be easily adjusted to the appropriate height and depth, allowing the chair to accommodate your child's needs as they grow. Also comes with lapstrap.

## Zoomi +

Following collaboration with a number of therapists, we developed Zoomi +. Complete with low back padded cover, armrest, quick release tray, 5-point harness, flat padded seat, slotted footrest and mobile skis, it offers the ideal solution for children who require a little extra postural support and ideal for home use.

## Benefits of Zoomi

- Economical seating solution
- Grows with your child
- Highly adjustable
- Tailored to the needs of your child
- Contemporary design
- Easy to clean
- Stable base with slimline footprint
- Can be used at home and in school
- Available in 3 vibrant colours

Zoomi seating system  
has been designed to  
grow with your child  
from 4mths to young  
adults

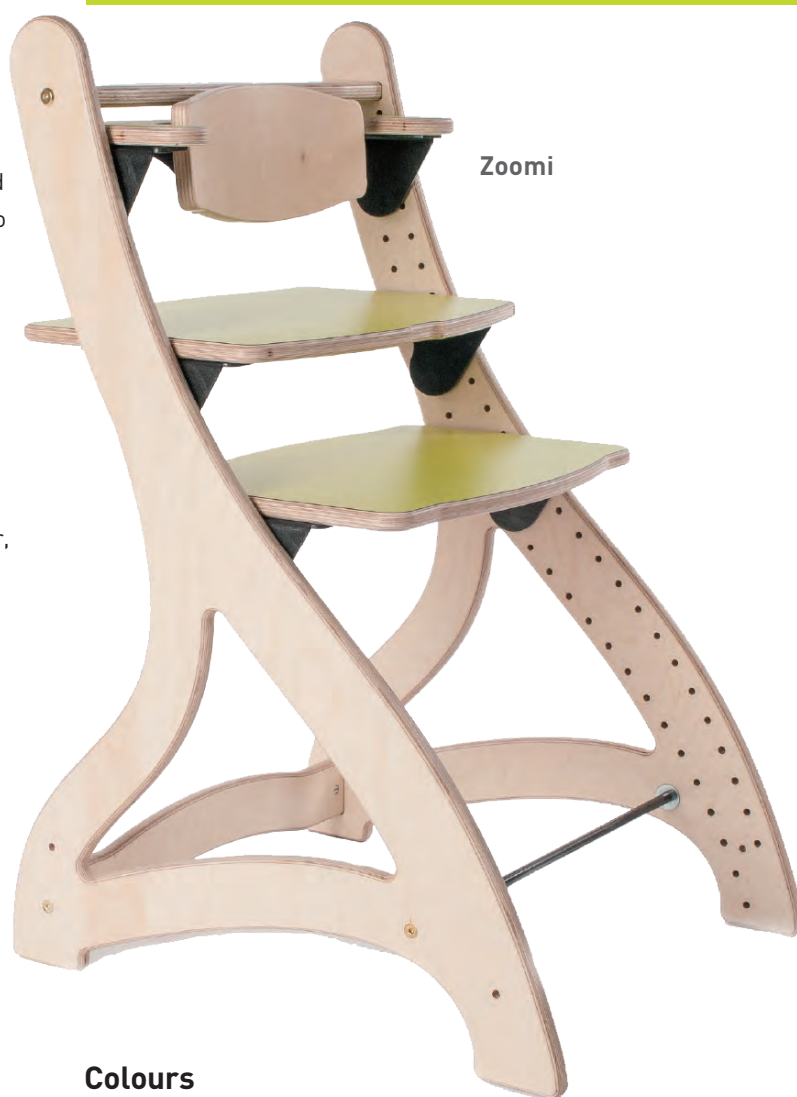

## Colours

The following colour options apply.  
No other options are available.



customisable  
one size fits all

buy online

**Standard key features  
Zoomi +**



Quick release tray



5 Point harness



Padded seat

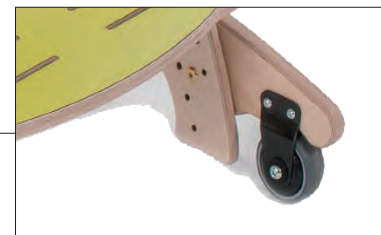

Mobile skis



Zoomi +

**Zoomi technical data**

all dimensions in mm unless otherwise stated

**Zoomi**

Height range	110 - 615
Width	450
Depth	550
Back height	260
Back angle (°)	95/100/105
Frame height	810
Max user weight (kg)	85
Product weight (kg)	16

**Colour**

	Zoomi standard	Zoomi +
Red	13011	13012
Lime	13021	13022
Blue	13031	13032

Instructional video available online

# zoomi/+

## optional accessories



### Thigh guides<sup>1</sup>

CODE TG010 - TG012

Provides thigh and hip support  
Can't be used with the contoured seat



### Child surround<sup>1</sup>

CODE SU001 - SU003

Converts the chair into a high chair  
Provides safety & support



### Armrest<sup>1</sup>

CODE AR017 - AR019

Provides arm support  
Used for the Quick release tray



### Mobile skis<sup>1</sup>

CODE SK105 - SK107

Easy to move



### Slotted footboard<sup>1</sup>

CODE FB027 - FB029

Can be used with sandals



### Transfer step<sup>1</sup>

CODE TS001 - TS003

Facilitates standing transfer



### Low padded backrest<sup>1</sup>

CODE BK188 - BK190

Gives higher levels of comfort



### High padded backrest<sup>1</sup>

CODE BK191 - BK193

Gives higher levels of comfort



### Contoured padded seat<sup>1</sup>

CODE SE054 - SE056

Promotes better posture  
Gives higher levels of comfort

<sup>1</sup> Codes vary depending on the colour



# zoomi/+

## all optional accessories

Accessories	Zoomi Code	Zoomi+ Code
mobile skis - red	SK105	
mobile skis - lime	SK106	
mobile skis - blue	SK107	
slotted footboard - red	FB027	
slotted footboard - lime	FB028	
slotted footboard - blue	FB029	
transfer step - red	TS001	TS001
transfer step - lime	TS002	TS002
transfer step - blue	TS003	TS003
flat padded seat - red	SE051	
flat padded seat - lime	SE052	
flat padded seat - blue	SE053	
contoured padded seat - red	SE054	SE054
contoured padded seat - lime	SE055	SE055
contoured padded seat - blue	SE056	SE056
pommel - red	PL032	PL032
pommel - lime	PL033	PL033
pommel - blue	PL034	PL034
thigh guides - red	TG010**	TG010
thigh guides - lime	TG011**	TG011
thigh guides - blue	TG012**	TG012
child surround - red	SU001	SU001
child surround - lime	SU002	SU002
child surround - blue	SU003	SU003
high padded backrest - red	BK191	BK191
high padded backrest - lime	BK192	BK192
high padded backrest - blue	BK193	BK193
low padded backrest - red	BK188	
low padded backrest - lime	BK189	
low padded backrest - blue	BK190	
armrest - red	AR017	
armrest - lime	AR018	
quick release tray - white	TR104*	

\* Quick release tray must be used with the Armrest accessory

\*\* Thigh Guide can only be used with Flat Padded Seat

	Size 1	Size 2	Size 3	Size 4
<b>Harnesses</b>	<b>Code</b>	<b>Code</b>	<b>Code</b>	<b>Code</b>
5-point harness	HN228	HN228	HN228	HN228
4-point harness - red	HN211	HN212	HN213	HN214
4-point harness - lime	HN221	HN222	HN223	HN224
4-point harness - blue	HN231	HN232	HN233	HN234

### Standard Zoomi

- Frame Low backrest
- Flat laminated seat
- Laminated footboard
- Lap strap

### Zoomi +

- Frame
- Low padded backrest
- Armrest
- Quick release tray
- 5-point harness
- Flat padded seat
- Slotted footboard
- Mobile skis



### 4-point harness

Provides extra trunk support

# desks

 buy online

## Perfect for school and home

Our range of desks have been designed to fit in to the school and home environment. The contemporary beauty of wood and the quality of the design enables our desks to stand the test of time.

## Study Desk

The Study Desk has been cleverly designed to allow your child to take part in various activities. The desk also contains ample storage space, so books and toys can be hidden away after they have been used. The Study Desk can be used with a variety of chairs, particularly the Heathfield and the Brookfield.

quality of the design  
enables our desks to  
stand the test of time



study desk

## Personal Tilt Desk

The Personal Tilt Desk is packed with additional features; the tilt functionality can transform the desk and allow your child to work on a variety of activities. The Personal Tilt Desk features a cut out and is highly adjustable, allowing easy access for a variety of chairs, including wheel chairs.



personal tilt desk

### Study Desk technical data

all dimensions in mm

Code	Size	Height range	Width	Depth	Max weight (kg)	Product weight (kg)
6967	1	345-520	450	600	80	19
6968	2	520-820	550	750	80	19

### Personal Tilt Desk technical data

all dimensions in mm

Code	Size	Type	Height range	Depth	Width	Cut-out	Max weight (kg)	Product weight (kg)
6894	1	static	465-715	600	685	410	80	15
6895	1	mobile	540-790	600	685	410	80	15
6896	2	static	465-715	600	805	410	80	16
6897	2	mobile	540-790	600	805	410	80	16

# hi-lo desk

## Quick Height Adjusting Desks

Our range of desks have been designed to fit into the school environment with larger sized desk tops for dynamic learning.

Each of the desks have a modern metal mechanism with a turn handle to easily change the height of the table to the desired height, ideal when there are multiple people having use of the table. Each top has a sliding bottom extension to secure pens and papers from sliding off the desk when they are being used in a tilted position.

Our desks can be used with a variety of chairs and can be made to match the colour of our Juni chairs.

designed to fit into the school environment with larger sized desk tops for dynamic learning

## Soft Close Tilting Desks

The hi-lo Deluxe Tilt Desk has a metal tilting mechanism and includes soft close hinges.

Adjust the height quickly with a simple turn handle.

## Hi-lo fixed top

Shown with Juni size 3 on mobile skis



Desk pictured shown with optional coloured lime top. Standard colour is natural wood, unless otherwise requested on the order.

buy online



Deluxe soft close hinges

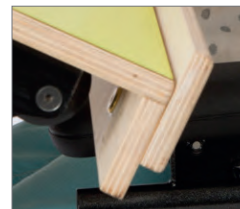

Pen stop

## hi-lo deluxe tilt desk



### Colours



### hi-lo fixed top

all dimensions in mm unless otherwise stated, price for standard natural wood top

Code	Height range	Width	Depth	Max weight (kg)	Product weight (kg)
2500	470 - 610	900	600	50	40
2501 (with castors)	545 - 685	900	600	50	40
2504	470 - 610	1200	600	50	45
2505 (with castors)	545 - 685	1200	600	50	45

### hi-lo deluxe tilting top

all dimensions in mm unless otherwise stated, price for standard natural wood top

Code	Height range	Width	Depth	Max weight (kg)	Product weight (kg)
2502	470 - 610	900	600	50	40
2503 (with castors)	545 - 685	900	600	50	40
2506	470 - 610	1200	600	50	45
2507 (with castors)	545 - 685	1200	600	50	45

# tables

range of tables and designs to suit most needs & requirements

## Activity Table

Our Activity Table is an ideal height adjustable table for younger children at nursery, school and home. The steel legs can be adjusted in height to ensure good seating posture of your child and can easily be folded for storage.

## Connectability

Our Connect range of rectangular and triangular tables have been designed to encourage good posture when your child is seated. All of the tables are adjustable in height and are extremely functional. They can be arranged into modular groups using rectangular and triangular configurations. Our Connect Tables meet a variety of different classroom needs to ensure an inclusive environment for children.



## Nest of tables

CODE 2445

We understand that storage space is often at a premium. Our Work 'n' Play Tables have been designed to combat storage issues. Each pack comes with 4 different size tables and a mobile base. The tables can be used separately or in conjunction with each other. Why not use the size 4 table as a work table, the size 3 as a stool and the size 1 as a footrest?



## Nest of tables - Code 2445

all dimensions in mm, includes each table

Size	Height	Width	Depth	Max weight (kg)	Product weight (kg)
1	110	355	265	80	4
2	170	460	320	80	6
3	290	565	375	80	8
4	450	720	460	80	10

buy online

connect  
triangular table



connect  
rectangular table



### Connect Rectangular Table technical data

all dimensions in mm

Code	Size	Height range	Width	Depth	Max weight (kg)	Product weight (kg)
2311	1	350-450	800	585	80	12
2312	2	425-575	800	585	80	12
2313	3	525-700	800	585	80	12

### Connect Triangular Table technical data

all dimensions in mm

Code	Size	Height range	Width	Depth	Max weight (kg)	Product weight (kg)
2361	1	350-450	1170	830	80	12
2362	2	425-575	1170	830	80	12
2363	3	525-700	1170	830	80	12

### Activity Table technical data

all dimensions in mm

Code	Size	Height range	Width	Depth	Max weight (kg)	Product weight (kg)
2251	1	385-595	750	600	80	12
2252	2	555-765	750	600	80	12

# supro

## Three in one

The Supro provides the option of supine, prone and vertical standing in one frame. Its design gives an angle range of 90° allowing it to achieve a horizontal and vertical position.

## Fully supportive

The Supro is a unique supine stander that has been designed for children from 2 years old to young adults who need to develop and maintain their ability to weight bear. It offers full posterior body contact and is suitable for children with little or no head control.

## Highly adjustable

The Supro offers high levels of adjustment in the knees, hips and chest to meet a wide range of postural needs. The Popliteal pads provide support behind the knee when the child is not fully able to straighten their legs.

 Colour Ranges  
See page 129 for colour options



a supine stander with  
a difference & building  
confidence





## Standard key features



Footrest and cocoon sandals



Plain tray



Lateral & pelvic supports



Knee cups

Supro pictured with soft head support  
(see accessories)

## Supro technical data

all dimensions in mm unless otherwise stated

Size	1	2	1	2
Upholstered board width	Standard		Wide	
Code	8256	8257	8258	8259
Thoracic support (top) to foot plate height	600-1070	700-1250	600-1070	700-1250
Pelvic support (top) to foot plate height	430-870	450-1010	430-870	450-1010
Knee block (top) to foot plate height	220-570	200-590	220-570	200-590
Foot plate to floor height (excluding sandals)	75	75	70	70
Max width (between thoracic supports)	330	330	430	430
Tray size (depth and width)	582 x 637	582 x 637	585 x 740	585 x 740
Angle (°)	0 to 90	0 to 90	0 to 90	0 to 90
Base frame	1140 x 570	1140 x 570	1130 x 610	1130 x 610
Max user weight (kg)	85	85	85	85
Product weight (kg)	55	56	57	59

Instructional video available online

# supro

## optional accessories



### **Bowl and cover<sup>1</sup>**

CODE BW006 & BW007

Perfect for wet or dry play activities



### **Soft head support**

CODE SP006 – SP007

Helps to support head position

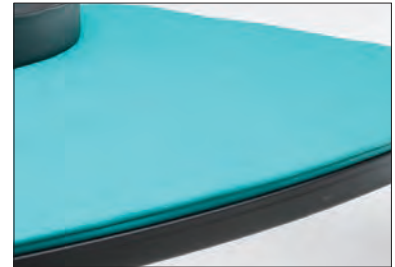

### **Padded tray top**

CODE TR028 – TR029

Provides comfort and support around your child's chest



### **Knee cups**

CODE KN011 - KN016

Maintains knee in position

Available in sizes 1 - 6



### **Caliper style kneecaps**

CODE KN017 - KN019

Extra knee support

Maintains knee position

Available in sizes 1 - 3



### **Sheepskin liners**

CODE KN022 - KN024

Maintains position of knee with added protection

Available in sizes 1 - 3



### **Popliteal foams (full thickness)**

CODE FM014

Provides support to back of knee



### **Popliteal foams (half thickness)**

CODE FM015

Provides support to the back of knee

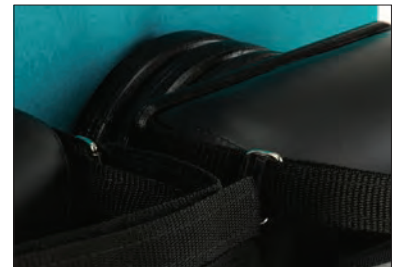

### **Kneecap spacers**

CODE KN020 - KN021

Provides additional height to the popliteal pad to accommodate differing degrees of knee contraction

<sup>1</sup> Must be factory fitted at the time this product is ordered

# supro

## all optional accessories

Accessories	Size 1 standard board Code	Size 1 wide board Code	Size 2 standard board Code	Size 2 wide board Code
knee cups size 1	KN011	KN011	KN011	KN011
knee cups size 2	KN012	KN012	KN012	KN012
knee cups size 3	KN013	KN013	KN013	KN013
knee cups size 4	KN014	KN014	KN014	KN014
knee cups size 5	KN015	KN015	KN015	KN015
knee cups size 6	KN016	KN016	KN016	KN016
caliper style kneecaps size 1	KN017	KN017	KN017	KN017
caliper style kneecaps size 2	KN018	KN018	KN018	KN018
caliper style kneecaps size 3	KN019	KN019	KN019	KN019
sheepskin liners for kneecaps size 1	KN022	KN022	KN022	KN022
sheepskin liners for kneecaps size 2	KN023	KN023	KN023	KN023
sheepskin liners for kneecaps size 3	KN024	KN024	KN024	KN024
popliteal foams (full thickness)	FM014	FM014	FM014	FM014
popliteal foams (half thickness)	FM015	FM015	FM015	FM015
kneecap spacers 12mm	KN020	KN020	KN020	KN020
kneecap spacers 18mm	KN021	KN021	KN021	KN021
additional pelvic/trunk lateral supports	SP010	SP010	SP011	SP011
soft head support for standard board	SP006	SP007	SP006	SP007
whitmyer pro series interface plate	WM001	WM001	WM001	WM001
whitmyer pro series vertical bar	WM002	WM002	WM002	WM002
<b>Tray accessories</b>				
padded tray top	TR028	TR028	TR029	TR029
suspension rail	SR012	SR012	SR013	SR013
tray grab rail full width	GB013	GB013	GB014	GB014
bowl and cover	BW006	BW007	BW006	BW007

Supro comes complete with upholstered board, lateral and pelvic supports, knee cups, cocoon sandals and plain tray.

# whirl

## Newly designed

The new and improved Whirl enables children from 12 months old to young adults to gradually develop and maintain their ability to weight bear by promoting excellent symmetry. It is suitable for children who require lower to higher levels of postural support and control. The Whirl is ideal for both school and home environments.

## Collaborating with you

Through working and collaborating with you, we have revolutionised the Whirl. We have adopted the essential elements of what your child needs from a stander; it provides excellent symmetry, it is extremely easy to use, it has multiple adjustments and, importantly, it is one that your child will enjoy using!

## Supportive

The Whirl offers high levels of adjustment. Anterior, pelvic and knee supports are height, width and angle adjustable to achieve correct positioning. Pelvic obliquity can be managed through the pelvic support, which incorporates a de-rotational feature. A flip-up footrest completes the package.

 Colour Ranges  
See page 129 for colour options

a prone stander with a  
unique module design,  
promoting excellent  
symmetry



## Standard key features



Activity tray and bowl



Pelvic Support



Adjustable knee cup



Standard adjustable footplates

Whirl's come complete with anterior, pelvic and knee supports, cocoon sandals, activity tray and bowl with cover.

## Whirl technical data

all dimensions in mm unless stated

Size	1	2
Code	8351/8353	8352 <sup>1</sup> /8354
Thoracic support (top) to foot plate height	*630-1020	*760-1270
Pelvic support (top) to foot plate height	*410-830	*560-1030
Knee support (top) to foot plate height	*130-420	*165-520
Foot plate to floor height (excluding sandals)	70	70
Max width (between thoracic supports)	300	460
Tray size (depth and width)	610 x 690	700 x 800
Angle (°)	0 to 30	0 to 30
Base frame	890 x 660	1020 x 710
Max user weight (kg)	70	90
Product weight (kg)	38	40

1 Codes for Whirl manual option

\*Minimum heights taken with footplate raised 50mm from floor

 Instructional video available online

# whirl

## optional accessories

Accessories	Size 1 Code	Size 2 Code	Size 3 Code	Size 4 Code	Size 5 Code
knee supports	KN006	KN007	KN008	KN009	KN010
de-rotational pelvic supports	SP003	SP004	SP022	SP023	
anterior supports	SP001	SP002	SP020	SP021	
shoulder harness	HN015	HN016	HN017	HN018	
tray grab rail full width	GB001	GB002			
suspension rail	SR001	SR002			
sliding footplate	8351	8352	8353	8354	

Whirl comes complete with anterior, pelvic and knee supports, cocoon sandal, activity tray and bowl with cover. Modular parts such as the anterior supports, de-rotational pelvic supports and shoulder harness are interchangeable on the 2 sizes of frames.



### Knee supports<sup>1</sup>

CODE KN006 - KN010

Height, width and depth adjustable to maintain knee position



### De-rotational pelvic supports<sup>2</sup>

CODE SP003, SP004, SP022, SP023

Adjusts and maintains hip position to control obliquity and rotation into a midline position



### Anterior supports<sup>2</sup>

CODE SP001, SP002, SP020, SP021

Adjustable to maintain trunk position



### Shoulder harness<sup>2</sup>

CODE HN015 - HN018

Provides support from the rear to encourage symmetry and spinal extension

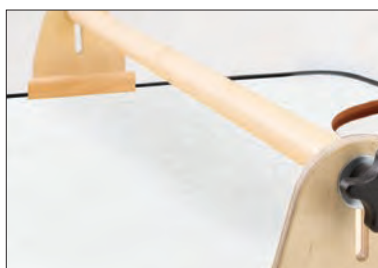

### Tray grab rail full width

CODE GB001 - GB002

Helps to stabilise limbs and trunk

<sup>1</sup> Available in sizes 1 - 5

<sup>2</sup> Available in sizes 1 - 4

# buddy, chi chi & sta



Chi Chi

## Supportive and affordable standing

Buddy and Chi Chi are an entry-level vertical stroller. Designed for younger children (please use technical data for sizing) who require low to moderate levels of support whilst weight bearing. Its design allows it to be used as a hip stroller suitable for targeted therapy for the development of specific areas such as trunk and shoulder girdle stability and head control.

## Inclusive and accessible

The Buddy and Chi Chi are slimline so can be used in schools enabling your child to perform numerous activities without feeling isolated from friends. Its colour and friendly character also brightens up any room. With the entry level cost we are delivering an entry-level stroller that is an accessible option to everyone.



Buddy

## Adjustability

The Buddy and Chi Chi offer numerous height and width adjustments in the chest and pelvic bands as well as additional angle adjustments in the knee supports and sandals. The Chi Chi has an additional height adjustment for taller or faster-growing children.

## Buddy, Chi Chi & Sta technical data

all dimensions in mm unless otherwise stated

Size	Size 1 Buddy	Size 2 Chi Chi	Size 2 Sta
Code	21001	21002	21003
Thoracic support (top) to foot board height	480-620	700-940	690-1005
Pelvic support (top) to foot board height	350-460	505-745	550-800
Knee supports (top) to foot board height	180-340	160-560	223-343
Foot board to floor height (excluding sandals)	120	120	194
Max width (between thoracic supports)	450	450	460
Tray size (depth and width)	415 x 520	415 x 520	420 x 506
Base frame (length, width and height)	650 x 498 x 786	800 x 625 x 993	1006 x 660 x 1200
Base frame (length, width and height) (high setting)	N/A	1020 x 650 x 1113	1006 x 660 x 960
User weight limit (kg)	40	60	60
Product weight (kg)	14	21	28

Buddy and Chi Chi comes complete with tray, chest band, pelvic band, knee supports and sandals. Straps and tray only available in lime. Tilt angle on Sta: 40° - upright.

## The Sta, a vertical and prone stroller

The physiological benefits of standing are enormous – not to mention the psychological benefits of being able to tackle activities. The STAnder aims to make standing enjoyable and practical for your child, while making it simple to achieve.

The STAnder is a vertical and prone entry-level stroller that enables children from five years old to young adults to gradually develop and maintain their ability to weight bear by promoting excellent symmetry. It is suitable for children who require lower to higher levels of postural support and control. The STAnder is ideal for both school and home environments.

The STAnder offers high levels of adjustment. Anterior, pelvic and knee supports are height, width and angle adjustable to achieve correct positioning. Pelvic obliquity can be managed through the pelvic support, which incorporates a de-rotational feature.



Sta

# bath chair

## Slimline and safe

Bath time for children is an opportunity to play with siblings and parents. Our Bath Chair's slimline design gives your child more space and freedom to bathe without restrictions. Handling the chair is also easy due to its lightweight frame.

## Adjustable

Our Bath Chair has an easy adjustable pommel so that the legs can be positioned slightly apart for better stability. The harness also offers various adjustments to suit your child's needs.

## Colour range

White



The Bath Chair comes with an adjustable harness and adjustable pommel as standard.

## Bath Chair technical data

all dimensions in mm unless otherwise stated

Size	1	2
Code	7607	7609
Seat height	35	35
Seat width	350	350
Seat depth	250	325
Back height	470	560
Max user weight (kg)	35	35
Product weight (kg)	5	8

freedom to bathe  
without restrictions with  
supportive help during  
bath times

 buy online

## accessories



### Telescopic handrail

CODE HR012

Length range: 470-700mm

Shipping weight: 1kg

Holding the handrail helps to  
maintain seating balance



# bath corner chair

 buy online

## More support

Our Bath Corner Chair is designed for children who require a little extra help with sitting balance whilst bathing. This is achieved by its angled back and hand rail, both of which provide additional security.

## Adjustable

Like the Bath Chair, our Bath Corner Chair provides numerous levels of adjustment. The pommel and pelvic strap can be adjusted to suit each individual child's needs.

## Compact

Lightweight and easy to clean, the Bath Corner Chair has a perfectly compact design. This allows it to sit low in the bath enabling your child to fully extend their legs in complete comfort. Its size also enables it to fit a wide range of baths.

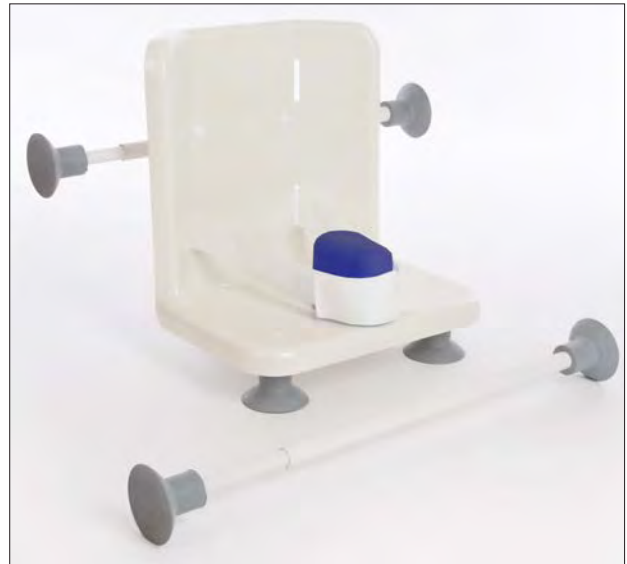

## accessories



### Bath back pad

CODE PD025

Provides extra comfort



### Telescopic handrail

CODE HR012

Holding the handrail helps to maintain seating balance

### Colour range

White

The Bath Corner Chair comes complete with velcro pelvic strap, adjustable pommel, telescopic back rail and telescopic handrail as standard.

## Bath Corner Chair technical data

all dimensions in mm unless otherwise stated

Size	1	2
Code	7511	7512
Seat height	75	75
Seat width	340	340
Seat depth	280	330
Back height	350	460
Max user weight (kg)	30	35
Product weight (kg)	3	4

"The Bath Corner Chair gives my child extra support and helps me to bathe her."

Christine, Mum, Reading

# chailey



greater postural support  
and comfort for effective  
toileting. Mobile option  
available

## A clinical approach

The Chailey seat is an innovative design borne from a special partnership with Chailey Heritage Clinical Services. Through close consultation with Chailey's clinical specialists, this seat has been developed to provide an improved and functionally correct posture.

## Perfect shape

The seat's contoured design gives your child greater postural support and comfort. Its shape ensures the pelvis is held securely in a position that facilitates bowel movement so that effective toileting is achieved.

## More than one option

The Chailey seat is available in two distinct packages. The 'Toilet seat' package which can be used in conjunction with a standard toilet. The 'Mobile' package stainless steel frame which can be used for both toileting and showering.

## Colour

White



## The Chailey is available in a choice of two packages:

- Chailey toilet seat package comes with the mounting bracket and full harness as standard. The seat can be used in conjunction with a standard toilet.
- Chailey mobile stainless steel toileting and showering package comes with a stainless steel mobile frame, footrest and full harness. Ideal solution for toileting and showering. For added convenience the frame folds for easy storage.



Shows optional footrest



Shows optional pan

### Standard key features Mobile Chailey



Full harness



Adjustable footrest with anti slip pattern



Stainless steel mobile frame package

### Chailey toilet seat technical data

all dimensions in mm unless otherwise stated

Size	1	2	3
Code	8301	8302	8303
Seat depth	280	380	400
Seat width	270	300	400
Back height	480	600	580
Max user weight (kg)	45	60	75
Product weight (kg)	11	15	17

### Chailey mobile stainless steel toilet seat packages technical data

all dimensions in mm unless otherwise stated

Size	1	2	3
Code	8307	8308	8309
Seat depth, width and height	See details of Chailey toilet seat above		
Seat to footplate	200-360	280-440	280-440
Bottom of seat to floor	490-540		
Folding frame (length x width x height)	950 x 490 x 280	980 x 560 x 300	
Max user weight (kg)	45	60	75
Product weight (kg)	19	23	24

■ Instructional video available online

# chailey

## optional accessories



### Stainless steel footrest

CODE FR027

Provides height adjustable foot support



### Footstraps for footrest (available with new footrests only)<sup>1</sup>

CODE ST032

Supports and maintains foot position



### Toilet mounting bracket

CODE BR001

Allows mounting of the seat on the toilet



### Pan

CODE BW003

Collection pan which fixes on to the Chailey mobile base



### Padded seat cover (seat lining)

CODE CL001 - CL003

Provides extra comfort and protection of the skin



### Full harness

CODE HN013 - HN014

Safety harness helps to support hip and trunk



### Padded shoulder strap

CODE PD034

Provides additional support and comfort over the shoulders



### Padded jacket with zip

CODE HN042 - HN044

Provides support with the added ability to zip or unzip the padded jacket



### Samba style headrest<sup>1</sup>

CODE HT014 - HT015

Provides extra head support  
Can be shaped by adjusting the sides  
Available in 2 sizes

<sup>1</sup> Must be factory fitted at the time the product is ordered

# chailey

## all optional accessories

<b>Mobile options</b>	<b>Size 1 Code</b>	<b>Size 2 Code</b>	<b>Size 3 Code</b>
mobile frame for static chailey toilet seat		MF002	MF002
stainless steel mobile frame for static chailey toilet seat	MF003	MF004	MF004
<b>Lower leg accessories</b>			
stainless steel footrest	FR027	FR027	FR027
footstraps for footrest	ST032	ST032	ST032
toilet mounting bracket	BR001	BR001	BR001
<b>Back &amp; head accessories</b>			
padded seat cover (seat lining)	CL001	CL002	CL003
full harness	HN013	HN014	HN014
padded shoulder strap	PD034	PD034	PD034
padded jacket with zip	HN042	HN043	HN044
samba style headrest size 1	HT014	HT014	HT014
samba style headrest size 2	HT015	HT015	HT015
<b>Other accessories</b>			
pan	BW003	BW003	BW003

# combi

## Progressive toileting

Our Combi toileting chair is a great starter chair. Its design enables it to be used as a supportive chair whilst at the same time providing numerous features to assist your child with the everyday toileting needs.

## Providing solutions

The Combi toileting chair's design also incorporates a potty for younger children. This can easily be removed to provide a commode seat for children who have progressed their toilet training.

## Adjustability

Good levels of adjustability are offered with the Combi toileting chair so that a wide range of needs can be met. Seat height and depth can be adjusted to suit the needs of your child.

The Combi toileting chair comes complete with potty, plastic commode seat, upholstered seat and velcro pelvic strap. You can choose from either our fixed arm or height adjustable arm Combi toileting chair.

enhance your toilet training program with the benefits of a supportive and adaptable chair



## accessories



### Splash guard

CODE SG001 - SG002

Assists in leg abduction and keeps toileting contained  
Requires Toggle handrail



### Toggle handrail

CODE HR014 - HR017

Allows child to hold and maintain balance and to sit with minimal support



### Higher backrest in lieu of standard

CODE BK172 - BK175

Provides extra back support for taller children

buy online

**Standard key features**



Fixed or height adjustable arm rests



Plastic commode seat & pot



Moulded Potty Seat



Adjustable seat height and depth

**Combi technical data**

all dimensions in mm unless otherwise stated

Size	1	2	3	4
Code	75511 / 7556 <sup>2</sup>	75521 / 7557 <sup>2</sup>	75531 / 7558 <sup>2</sup>	7554 <sup>1</sup> / 7559 <sup>2</sup>
Seat height <sup>3</sup>	215-290	275-375	300-400	340-450
Seat width	290	325	365	435
Seat depth	205-290	245-355	310-385	350-440
Back height	325	370	400	500
Max user weight (kg)	35	45	55	65
Product weight (kg)	11	13	14	15

<sup>1</sup> Adjustable arm / <sup>2</sup> Fixed arm

<sup>3</sup> Seat height is to the top of upholstered seat (deduct 25mm for the height of the potty and deduct 40mm for the height of the commode seat)



Colour Ranges

See page 129 for colour options

# combi

	Size 1	Size 2	Size 3	Size 4
Lower leg accessories	Code	Code	Code	Code
skis	SK051	SK052	SK053	SK054
ski & half footrest	SK041	SK042	SK043	SK044
ski & full footrest	SK037	SK038	SK039	SK040
reversible footboard	FB023	FB024	FB025	FB026
adjustable footrest	FR010	FR011	FR012	FR013
mobile dolly base	DL012	DL013	DL014	DL015
footrest & straps <sup>1</sup>	FP002	FP003	FP004	FP005
4 glisdomes complete with screws	GD001	GD001	GD001	GD001
Handrail accessories				
splash guard	SG001	SG002	SG002	SG002
toggle handrail	HR014	HR015	HR016	HR017
tray	TR006	TR073	TR074	TR005
Back accessories				
higher backrest in lieu of standard	BK175	BK172	BK173	BK174
adjustable height push handle	PH028	PH006	PH007	PH008
fixed height push handle	PH029	PH012	PH013	PH014
Cushions for adjustable arm Combi only				
25mm pelvic cushions (pair)	CS005	CS006	CS007	CS008
38mm pelvic cushions (pair)	CS014	CS015	CS016	CS017
50mm pelvic cushions (pair)	CS023	CS024	CS025	CS026
62mm pelvic cushions (pair)	CS032	CS033	CS034	CS035
75mm pelvic cushions (pair)	CS041	CS042	CS043	CS044
25+25mm pelvic cushions (pair)	CS050	CS051	CS052	CS053
38+25mm pelvic cushions (pair)	CS231	CS232	CS233	CS234
50+25mm pelvic cushions (pair)	CS077	CS078	CS079	CS080
62+25mm pelvic cushions (pair)	CS086	CS087	CS088	CS089
75x50mm wedge cushions (pair)	CS095	CS096	CS097	CS098
75x62mm wedge cushions (pair)	CS104	CS105	CS106	CS107
75x75mm wedge cushions (pair)	CS113	CS114	CS115	CS116
75x100mm wedge cushions (pair)	CS122	CS123	CS124	CS125

\*suitable for adjustable arm chairs only

<sup>1</sup> Available on Mobile dolly base, Reversible footboard and Skis with full footrest

Combi comes complete with potty, plastic commode seat, upholstered seat and velcro pelvic strap.

Available with fixed arm or height adjustable arm chair.



Colour Ranges

See page 129 for colour options



buy online

# potty chair

## Fully supportive

Our Potty Chair has been designed specifically for young children who require assistance with sitting balance and need more reassurance when toileting. Its freestanding and highly supportive design means that it fits well in nursery, school and home environments. The sides of the Potty Chair provide your child with the privacy they sometimes need whilst toileting. Holding the handrail helps to maintain seating balance.

## Potty aperture

Many potties have a round aperture which can make toileting extremely difficult for children with slightly narrow hips. Our Potty Chair's aperture has been designed to ensure improved comfort and toileting performance.

## accessories



### Footboard

CODE FB012 – FB014

Foot support that prevents chair movement. Factory fit at time of order



### Splash guard

CODE SG001 – SG002

Assists in keeping legs apart and toileting contained  
Requires Toggle handrail



freestanding and highly supportive design.

The handrail helps to maintain sitting balance

## Potty Chair technical data

all dimensions in mm unless otherwise stated

Size	1	2	3
Code	7525/7528 <sup>1</sup>	7526/7529 <sup>1</sup>	7527
Seat height	150-330	220-430	270-450
Seat width	310	380	475
Seat depth	330	380	430
User weight (kg)	35	45	55
Product weight (kg)	10	11	13

<sup>1</sup> Folding version (not available in size 3)



Colour Ranges

See page 129 for colour options

Instructional video available online

The Potty Chair comes complete with potty, handrail and pelvic strap.

# easi-lift changing bench

## No floor fixing

Most height-adjustable changing tables require fitting to both the wall and floor. The Easi-Lift Changing Bench has been designed to require wall fixing only. This is particularly beneficial where the type of floor, surface pipe work or cabling prevent floor installation.

## Reduces back injury

The Easi-Lift Changing Bench has a travel range of 500mm to meet varying needs and the bench can easily be set to a safe and suitable working height to help prevent the risk of back injury to the carer.

## Space saving design

Easi-Lift Changing Bench is a compact, electrically operated wall-mounted changing bench designed to fit in a dry room environment where space is at a minimum, folding away to save space after use.

## Technical data

- No floor fixing required
- Weight capacity of 150kg
- Travel range of 500mm
- Protrudes 305mm from the wall when stored

easily set to a safe and  
suitable working height,  
with a travel range of  
500mm to meet varying  
needs

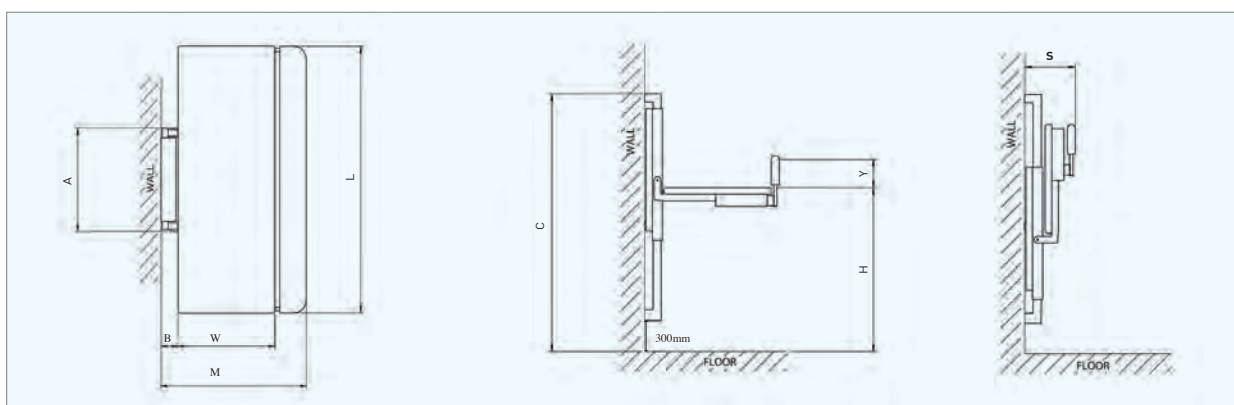

### Standard Key features



Electrically operated



Folds away to save space



Stowaway safety rail

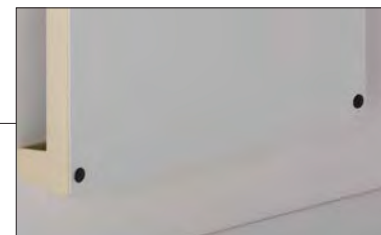

Requires wall fixing only

Mild Steel Powder Coated	Size	Table Dimensions			Travel Range	Wall Frame Width	Wall Frame Depth	Wall Frame Height	Safety Side Height	Stored Width	Max User Weight	Product Weight
		L mm	W mm	M mm								
3081	1	1200	550	875	450 - 950*	700	110	1620*	165	305	150	80
3082	2	1300	550	875	450 - 950*	700	110	1620*	165	305	150	82
3083	3	1400	600	925	450 - 950*	700	110	1620*	165	305	150	84
3084	4	1500	600	925	450 - 950*	700	110	1620*	165	305	150	86
3085	5	1600	650	975	450 - 950*	700	110	1620*	165	305	150	88
3086	6	1700	650	975	450 - 950*	700	110	1620*	165	305	150	90
3087	7	2000	650	975	450 - 950*	700	110	1620*	165	305	150	94
3088	8	2100	650	975	450 - 950*	700	110	1620*	165	305	150	96

\*dependent on installed height

\* Actual product may vary subject to design upgrades  
All technical data and drawings available upon request.

 Colour Ranges  
See page 129 for colour options

# easi-lift shower stretcher

## Easy adjustment

The Easi-Lift Shower Stretcher has been designed to help you move the user up and down with ease whilst they are on the stretcher. It is electronically operated with a height range of 500mm, which allows a safe and suitable working height to prevent the risk of back injury to the carer.

## Contemporary design

The unobtrusive and neutral design of the Easi-Lift Shower Stretcher allows it to fit into a wide range of environments, especially with its stainless steel and powder coated frame. The need for floor fixing has been eliminated making it the perfect choice for areas where the floor type, surface pipe work or cabling prevent floor installation.

## Easy storage

The compact design coupled with the ability to fold the stretcher away when it is not in use makes this the ideal product for times when space is limited.

## Technical data

- No floor fixing required
- Weight capacity of 200kg
- Travel range of 500mm

the ideal wet room  
product for times when  
space is limited



Picture shows optional 1400mm safety guard

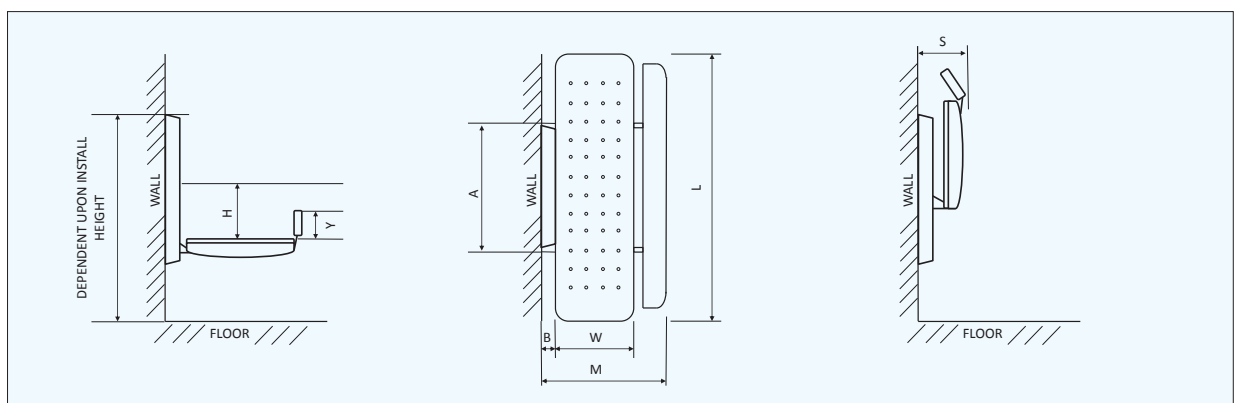

### Standard key features



Requires wall fixing only



Stainless steel frame with powder coated finish



**Optional** integral vinyl headrest



Folds away to save space



### Colour



Stainless Steel Powder Coated		Size	Table Dimensions			Travel Range	Wall Frame Width	Wall Frame Depth	Safety Guard Height	Stored Width	Max User Weight	Product Weight
Without Head-rest	With Head-rest		L mm	W mm	M mm							
3191	3291	1	1400	650	1000	450 - 950*	750	110	145**	270	200	82
3192	3292	2	1500	650	1000	450 - 950*	750	110	145**	270	200	83
3193	3293	3	1600	650	1000	450 - 950*	750	110	145**	270	200	84
3194	3294	4	1700	650	1000	450 - 950*	750	110	145**	270	200	85
3195	3295	5	1800	650	1000	450 - 950*	750	110	145**	270	200	86
3196	3296	6	1900	650	1000	450 - 950*	750	110	145**	270	200	87

\*dependent on installed height \*\*safety guard is an optional accessory

\* Actual product may vary subject to design upgrades

Wall frame height 1320mm

All technical data and drawings available on upon request.

# shower stretcher fixed height

economical washing  
and showering solution  
with this durable and  
slimline product

## Economical solution

The Shower Stretcher Fixed Height is our entry-level product and an economical washing and showering solution for the user. This durable and slimline product represents real value for money.

## Makes bathing easier

The Shower Stretcher Fixed Height is designed to allow the washing or showering of the user whilst in a horizontal position. It can be fixed directly above a bath making it the perfect solution for the home.

## Added headrest

The Shower Stretcher Fixed Height, along with all of our shower stretchers, can be enhanced with the optional integral vinyl headrest. The headrest features a paddle lift adjustment, which allows it to be locked securely into the desired position.



## Technical data

- No floor fixing required
- Permanently fixed at the desired height
- Weight capacity of 200kg

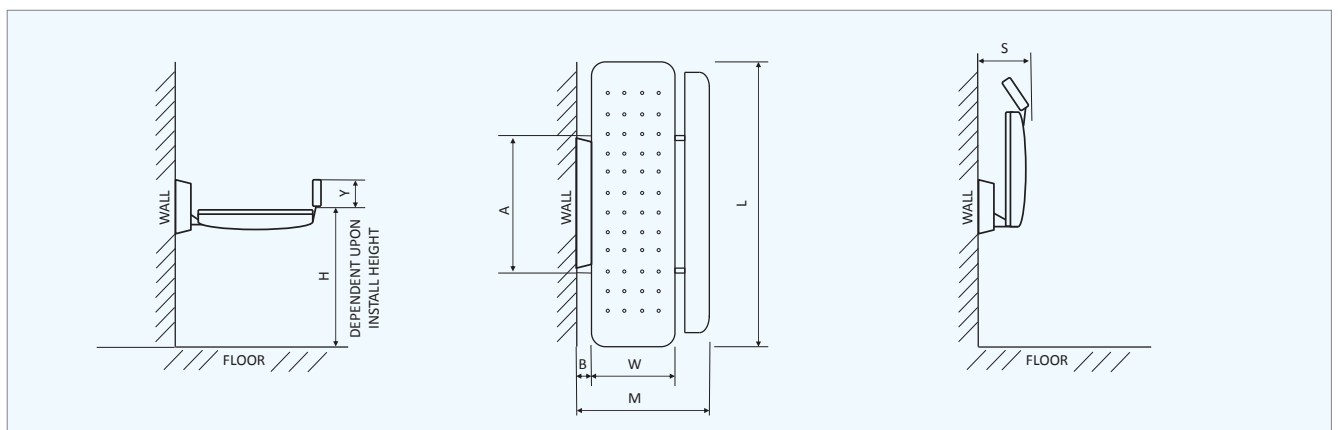

### Standard key features



Requires wall fixing only



Stainless steel frame with powder coated finish



Optional integral vinyl headrest



Folds away to save space



### Colour



Stainless Steel Powder Coated		Size	Table Dimensions			Travel Range	Wall Frame Width A mm	Wall Frame Depth B mm	Safety Guard Height Y mm	Stored Width S mm	Max User Weight kg	Product Weight kg
Without Head-rest	With Head-rest		L mm	W mm	M mm							
3171	3271	1	1400	650	1000	Fixed	665	80	145*	240	200	75
3172	3272	2	1500	650	1000	Fixed	665	80	145*	240	200	76
3173	3273	3	1600	650	1000	Fixed	665	80	145*	240	200	77
3174	3274	4	1700	650	1000	Fixed	665	80	145*	240	200	78
3175	3275	5	1800	650	1000	Fixed	665	80	145*	240	200	79
3176	3276	6	1900	650	1000	Fixed	665	80	145*	240	200	80

\*safety guard is optional accessory  
All technical data and drawings available upon request.

# shower stretcher adjustable

perfect for any room  
environment and for  
rooms with limited  
space

## Height adjustable

The Shower Stretcher Adjustable Height allows you to manually set the height of the stretcher to the desired position, simply by turning the handle clockwise to lower and anti-clockwise to elevate.

## Wall mounted

The Shower Stretcher Adjustable Height is wall mounted and does not require fixing to the floor. Its stainless steel frame and vinyl cover makes it perfect for any room environment.

## Space saver

The Shower Stretcher Adjustable Height is ideal for rooms that have limited space. The fold-away functionality of the stretcher allows it to be stored away when it is not being used, allowing maximum use of room space.

## Technical data

- No floor fixing required
- Weight capacity of 200kg
- Travel range of 350mm
- Height range is manually operated

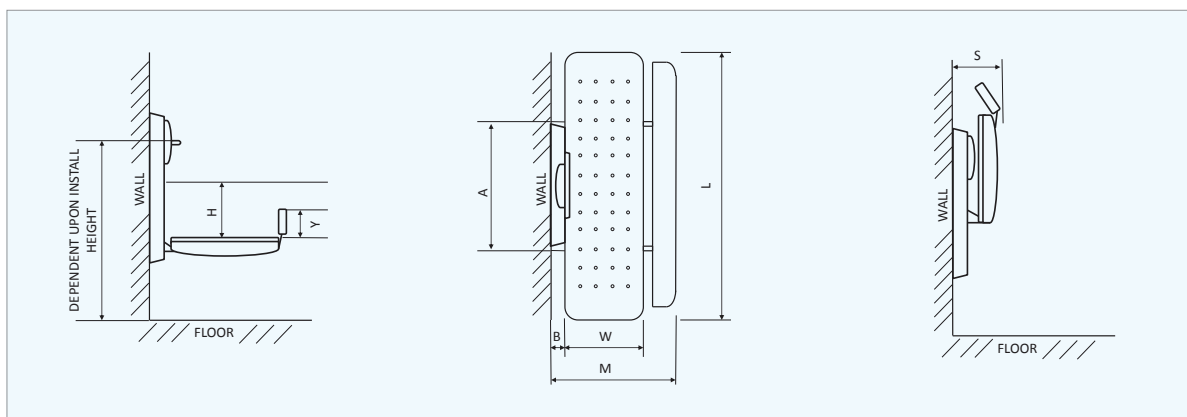



### Standard key features



Height range is manually operated



Stainless steel frame with powder coated finish



Optional integral vinyl headrest



Folds away to save space



### Colour



Stainless Steel Powder Coated		Size	Table Dimensions			Travel Range mm	Wall Frame Width mm	Wall Frame Depth mm	Safety Guard Height mm	Stored Width mm	Max User Weight kg	Product Weight kg
Without Head-rest	With Head-rest		L mm	W mm	M mm							
3181	3281	1	1400	650	1000	450 - 800*	665	80	145**	240	200	80
3182	3282	2	1500	650	1000	450 - 800*	665	80	145**	240	200	81
3183	3283	3	1600	650	1000	450 - 800*	665	80	145**	240	200	82
3184	3284	4	1700	650	1000	450 - 800*	665	80	145**	240	200	83
3185	3285	5	1800	650	1000	450 - 800*	665	80	145**	240	200	84
3186	3286	6	1900	650	1000	450 - 800*	665	80	145**	240	200	85

\*depending on installed height \*\*safety guard is optional accessory  
All technical data and drawings available upon request.

# hi-riser

## Robust yet slimline

Hi-Riser is an electrically operated wall-mounted changing table that is suitable for children and adults of up to 200kg. Despite its robust structure, the Hi-Riser has a slimline design that ensures it fits easily into most environments.

## Easy transfers

The Hi-Riser has been designed so that it can be used with most mobile or ceiling hoists. The unique safety side rail stows away, streamlining access for transfers from a wheelchair, shower and toileting chair. The Hi-Riser also benefits from an impressive travel range of 600mm.

## Providing options

We understand that every need is different, which is why the Hi-riser comes in seven different sizes that cater from young children through to adults. The Hi-Riser comes in a cream powder coated frame for dry environments or stainless steel frame for damp environments.

## Technical data

- Electrically operated
- Wall and floor mounted
- Wall mounting kit included
- Weight capacity of 200kg
- Impressive travel range of 600mm

robust structure and  
slimline design with an  
impressive travel range of  
600mm and available in  
7 sizes

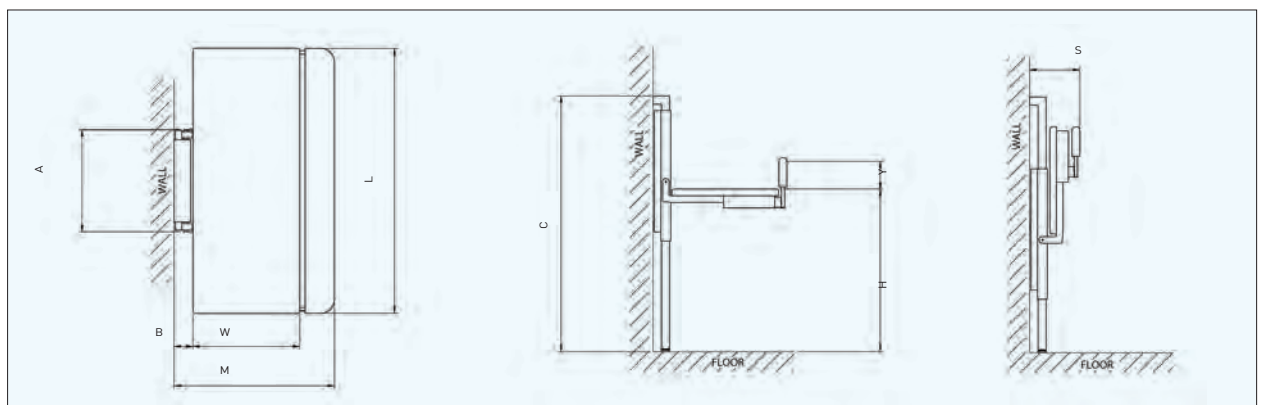

### Standard key features

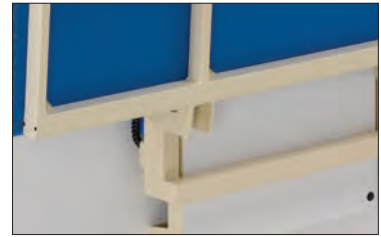

Cream powder coated for dry room environments



Stainless steel for damp room environments



Stowaway side rail



Folds away to save space



Mild Steel Powder Coated	Stainless Steel	Size	Table Dimensions			Travel Range H mm	Wall Frame Width A mm	Wall Frame Depth B mm	Wall Frame Height C mm	Safety Side Height Y mm	Stored Width S mm	Max User Weight kg	Product Weight kg
			L mm	W mm	M mm								
3041	3051	1	1200	550	875	400 - 1000	700	110	1550	165	305	200	80
3042	3052	2	1300	550	875	400 - 1000	700	110	1550	165	305	200	82
3043	3053	3	1400	600	925	400 - 1000	700	110	1550	165	305	200	84
3044	3054	4	1500	600	925	400 - 1000	700	110	1550	165	305	200	86
3045	3055	5	1600	650	975	400 - 1000	700	110	1550	165	305	200	88
3046	3056	6	1700	650	975	400 - 1000	700	110	1550	165	305	200	90
3047	3057	7	1800	650	975	400 - 1000	700	110	1550	165	305	200	92

All technical data and drawings available upon request.

 Colour Ranges  
See page 129 for colour options

# hi-riser shower stretcher

highly supportive yet  
soft and comfortable  
for children and adults  
up to 150kg

## Two in one

The Hi-Riser shower stretcher is an easy to use two-in-one wall and floor mounted showering and changing table. Its robust yet slimline design makes it suitable for children and adults of up to 150kg. Its versatility means it offers the ideal solution for swimming, hydrotherapy and bathroom environments.

## Comfortable & hygienic

The Hi-Riser Shower Stretcher has been designed with reinforced PVC, making it highly supportive yet soft and comfortable to lie on. Its stainless steel frame facilitates easy cleaning, making it a perfect choice for multi-user environments.

## Technical data

- Handset works safely in wet room environments
- Drainage pipe & fasteners included
- Wall and floor mounted
- Weight capacity of 150kg
- Travel range of 570mm
- Protrudes 300mm from the wall when stored



## Quick drainage

The Hi-Riser Shower Stretcher is supplied with flexible pipe work to use with a suitable floor drain or, alternatively, it can be plumbed in. Water can easily be drained away using the drainage pipe, which can also be detached for cleaning purposes.

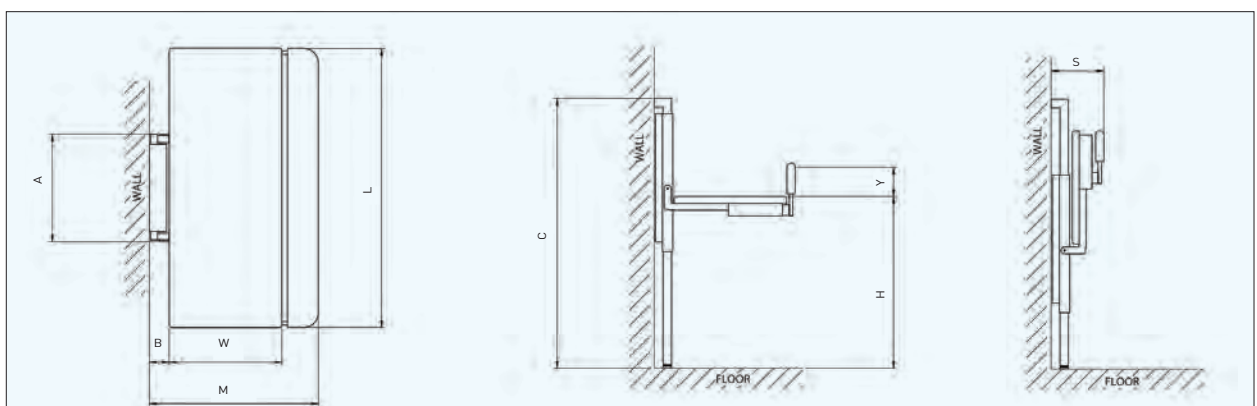

### Standard key features



Electrically operated



Folds away to save space



Folding side rail



Drainage apron, pipe & fasteners

### Colour



Stainless Steel	Size	Table Dimensions			Travel Range	Wall Frame Width A mm	Wall Frame Depth B mm	Wall Frame Height C mm	Safety Side Height Y mm	Stored Width S mm	Max User Weight kg	Product Weight kg
		L mm	W mm	M mm								
3063	1	1400	650	1110	390 - 960	700	110	1550	165	300	150	80
3067	2	1800	650	1110	390 - 960	700	110	1550	165	300	150	85

All technical data and drawings available upon request.

# mobi changer

fully mobile changing table that requires no installation, an extremely cost effective option

## Room to room

The Mobi Changer is a fully mobile changing table that requires no installation or fixing. Its compact and slimline design means it can be easily manoeuvred from room to room, offering an extremely cost effective option for multi-transfer or multi-user environments.

## Height adjustable

The electrically operated Mobi Changer provides an excellent travel range of 480mm and can be lowered and elevated at the touch of a button. Safe and suitable working heights can be easily achieved which helps prevent the risk of back injury to the carer.

## Easy transfers

The Mobi Changer has been designed to ensure sufficient clearance for a wide number of hoists. Its mobility and unique stowaway side rails enable safe and easy handling. Whether you are transferring from a bed, wheelchair or toileting chair, the Mobi Changer is the perfect solution.

## Technical data

- Cream powder coated frame for dry rooms
- Stainless steel for damp room environments
- Weight capacity of 227kg
- Travel range of 480mm
- Comes with a wall mounted charger and 2 batteries

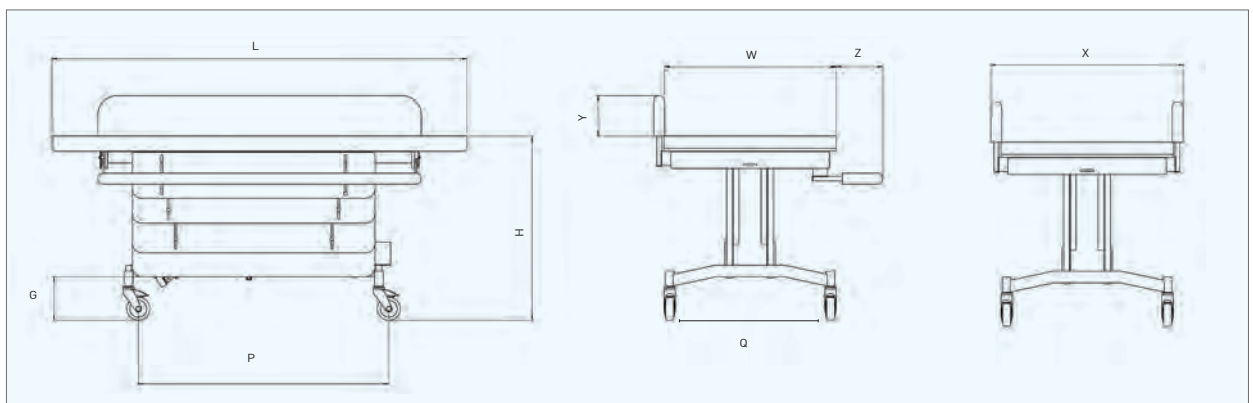

buy online

## Standard key features



Optional angled back



Easy to clean padded surfaces



Stowaway side rails



Mobile and easy to manoeuvre

Mild Steel Powder Coated	Stainless Steel	Size	Table Dimensions		Travel Range	Safety Sides		Safety Sides Operational Space	Castor Centres		Nominal Clearances	Max User Weight	Product Weight
			L mm	W mm		H mm	Width X mm		Height Y mm	Z mm			
3121	3141	1	1400	750	470 - 950	840	165	200	1090	700	190	125	86
3122	3142	2	1600	750	470 - 950	840	165	200	1090	700	190	125	88
3123	3143	3	1800	750	470 - 950	840	165	200	1090	700	190	125	90
3124	3144	4	2000	750	470 - 950	840	165	200	1090	700	190	125	100

Further technical data and drawings available on our website.

 Colour Ranges  
See page 129 for colour options

# mobi heavy duty changer

## Meeting bariatric needs

The Mobi Heavy Duty Changer has been designed to meet the needs of bariatric users. Its powerful 12K Newton motor, coupled with the extra wide mattress platform, makes it the ideal solution.

## Manoeuvrability

The benefit of the Mobi range of products is that they do not require any wall mounting or floor fixing. They are easy to manoeuvre which means that the user can be transported from room to room with no trouble (door opening has to be 1100mm or more).

## Height adjustable

The Mobi Heavy Duty Changer is electronically operated, which makes adjusting the height of the table simple, this is beneficial for both the carer and user.

## Technical data

- No installation required
- Electronically operated
- Dry room environments only
- Weight capacity of 500kg
- Travel range of 370mm
- Wall mounted charger and 2 batteries

designed to meet the  
needs of bariatric users,  
includes an powerful  
motor and extra wide  
mattress

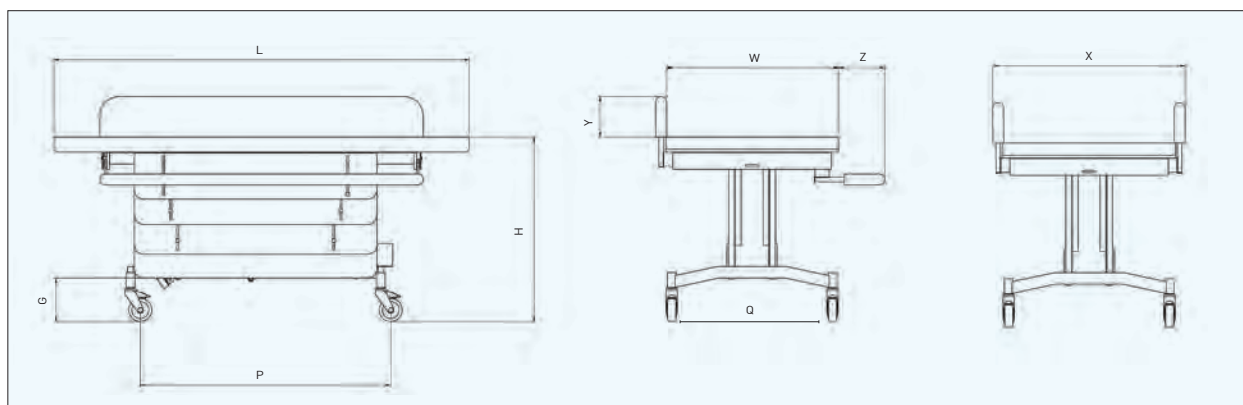



### Standard key features



Travel range of 370mm



Stowaway side rails



Electronically operated



Mobile and easy to manoeuvre



Mild Steel Powder Coated	Size	Table Dimensions		Travel Range	Safety Sides		Safety Sides Operational Space	Castor Centres		Nominal Clearances	Max User Weight	Product Weight
		L mm	W mm		Width X mm	Height Y mm		Z mm	P mm			
3161	1	2000	960	550 - 920	1050	165	200	1500	800	150	500	100

Further technical data and drawings available upon request.

# mobi shower trolley

a powered, height adjustable shower trolley and has two safety side rails for safety and confident showering

## Safe showering

For many children and adults, conventional methods of bathing and showering can be difficult and even hazardous. The Mobi Shower Trolley is a powered, height-adjustable shower trolley specifically designed to enable the user to be safely and easily washed or showered by their carer.

## Reduces back injury

The Mobi Shower Trolley offers a range of height adjustments to enable the carer to shower and change the user at a safe and suitable working height. This reduces the risk of back injury for the carer.

## Stowaway side rails

The Mobi Shower Trolley has been designed with two unique safety side rails that can be easily stowed away beneath the trolley. This allows maximum clearance for safe, easy transfer and use.

## Technical data

- No installation required
- Length of table is 1800mm
- Weight capacity of 220kg
- Travel range of 460mm

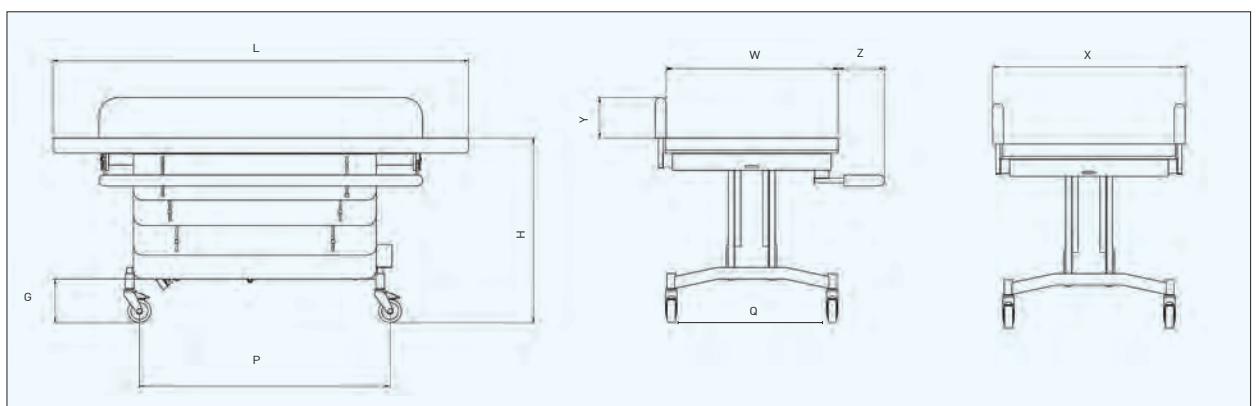

### Standard key features



Travel range of 370mm

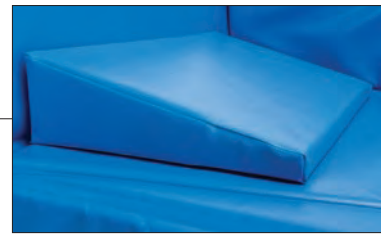

Wedge shaped pillow



Drainage panel and pipe



Mobile and easy to manoeuvre

### Colour



Stain- less Steel	Size	Table Dimensions			Travel Range		Safety Sides		Safety Sides Operational Space Z mm	Castor Centres		Nominal Clearances G mm	Max User Weight kg	Product Weight kg
		L mm	W mm	H mm	Width X mm	Height Y mm	P mm	Q mm						
3151	1	1800	750	465 - 925	840	195	200	1090	700	190	125	86		

Further technical data and drawings available upon request.

# changing & showering

## optional accessories



### Headrest

CODE Please refer to product

Our 3 shower stretcher products can all be enhanced with the optional integral vinyl headrest. The headrest must be ordered at the same time the stretcher is ordered and cannot be fitted retrospectively. Our frames have been designed with the ability to have the headrest at each end of the stretcher (please specify which end, at point of order). The headrest features a paddle lift adjustment, which allows it to be locked securely in the desired position.

#### Relevant products:

Easi-Lift Shower Stretcher, Shower Stretcher Fixed Height & Shower Stretcher Adjustable Height



### Safety guard

CODE ECSG01

Enhance the safety of any of the 3 shower stretcher products with the safety guard accessory. The safety guard must be ordered at the same time the stretcher is ordered and cannot be fitted retrospectively. The safety guard locks securely into position and provides extra support whilst the user is on the stretcher. Please note that the safety guard does not stow away (as per the Mobi changer). The safety guard is one size in length (1400mm).

#### Relevant products:

Easi-Lift Shower Stretcher, Shower Stretcher Fixed Height & Shower Stretcher Adjustable Height



### Angled back

CODE BE002 (size 1), BE003 (size 2) and BE004 (size 3)

The angled back is only available for the powder coated Mobi changer and must be requested when placing an order, as it cannot be fitted retrospectively.



### Additional charging station & battery

CODE CB008 (charger & battery)  
CODE BE005 (battery only)

#### Relevant products:

Mobi Changer

## Summary of product suitability depending on room environment

Environment	Suitable Products
Dry room environment	Powder coated benches (PC mobi, easi-lift & hi-riser)
Damp room environment i.e. bath/changing rooms (not for use with direct water)	Stainless steel benches (SS mobi & ss hi-riser)
Wet room environment i.e. walk in shower	Shower trollies, easi-lift shower stretcher & hi-riser shower stretcher



Samba pictured with Prism hoist, showing suitability for hoist transfers.

# conductive education packs

"Our Plinth plays a key role in our son's therapy programme."

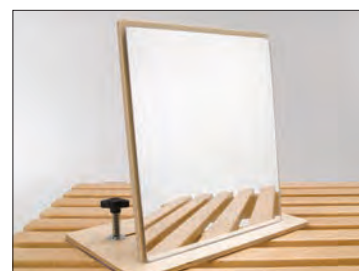

Picked packs especially for home and school use. Easy ordering with single pack part numbers.

## **Our Infant Conductive Education Pack includes:**

### **CODE 4140**

- Folding Plinth in size 1
- Ladder and Platform in size 1
- Adjustable Height Box Stool in size 1
- 1 Handstick
- 125mm quick fix handrail
- Small quick fix mirror
- 1 Dycem mat (350mm x 250mm)
- Small plinth tray
- 25/50mm raise blocks

## **Our Junior Conductive Education Pack includes:**

### **CODE 4141**

- Folding Plinth in size 2
- Ladder and Platform in size 2
- Adjustable Height Slatted Stool in size 2\*
- 1 Handstick
- 125mm quick fix handrail
- Large quick fix mirror
- 1 Dycem mat (350mm x 250mm)
- Half plinth cover board
- 50/70mm raise blocks

# footrests, steps & bars buy online

## Interlocking steps

CODE 4188

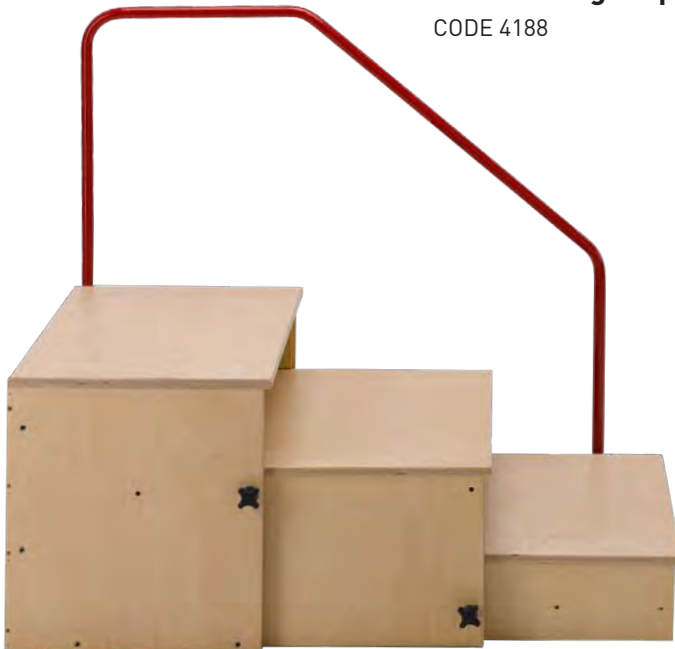

## Interlocking steps

Our 3 Interlocking Steps come complete with a single handrail that can be locked into position. All 3 steps have the same width (625mm) and depth (370mm). The lower step is at a height of 125mm, the middle step at 250mm and the platform at 375mm. Max user weight of 100kg and product weight of 20kg.

An extra handrail (CODE 4189) for the Interlocking steps is available to buy separately.

## improving your childs balance

## Parallel bars

CODE 4292 - 4293

Our Parallel Bars are height and width adjustable and aim to improve your child's balance. They are extremely easy to use and adjust.



## Parallel Bars technical data

all dimensions in mm unless otherwise stated

Size	1	2
Code	4292	4293
Length	2000	2660
Height min	360	500
Height max	540	820
Width min	380	500
Width max	600	730
Max user weight (kg)	80	100
Product weight (kg)	15	25

## Interlocking footrest

CODE 4185-4186

Our Interlocking Footrest is portable and can be used with a number of seating or therapy products. There are three interlocking footrests and they can be used together or separately. Available in 2 sizes.



## Interlocking Footrest technical data

all dimensions in mm unless otherwise stated

Size	1	2
Code	4185	4186
Width	390	420
Depth	340	300
Height min	50	75
Height max	140	230
Heights individually	50 - 63 - 75	75 - 88 - 100
Max user weight (kg)	80	80
Product weight (kg)	5	5

# ladders

## Walking ladders

Our Walking Ladders are designed to assist with standing and walking. They also offer support when the ladders are held during sitting and toileting. A Ladder footboard (CODE 4321) is also available to help keep the legs abducted whilst walking.

## Ladders & Platforms

Our Ladders and Platforms are ideal for therapy programmes and can be used for sitting as well as standing. With 3 sizes of Platforms and a variety of accessories, you can build the Ladder to suit your child's needs. (platforms cannot be used on the walking ladders).

### Ladder technical data

all dimensions in mm unless otherwise stated

Size	1	2	3
Code	4373	4374	4375
Height	900	1200	1500
Width	500	500	500
Rung diameter	22	22	22
Max User weight (kg)	50	50	50
Product Weight (kg)	9	12	15

### Platform technical data

all dimensions in mm unless otherwise stated

Size	1	2	3
Code	4376	4377	4378
Width	400	400	400
Depth	250	300	350
Max User weight (kg)	50	50	50
Product Weight (kg)	3	4	5

## optional accessories



### Ladder box

CODE 4370 (available for all ladders with a rung diameter of 19mm or 22mm)



### Adjustable platform armrests

CODE 4470 (pair)



### Adjustable platform supports

CODE 4460 (pair)

"Our Plinth plays a key role in our son's therapy programme."



### Walking Ladder technical data

all dimensions in mm unless otherwise stated

Size	1	2	3
Code	4313	4314	4315
Height	900	1200	1500
Width	550	600	650
Rung diameter	19	22	25
Max User weight (kg)	50	50	50
Product Weight (kg)	7	8	9





## High & Low Ladder Back Chairs

Our Ladder Back Chairs help to improve concentration and engage your child through a structured therapy programme. Designed for progressive use by children from an early age. Available with high and low back.

Designed for progressive use



## Wall ladder

Our Wall Ladders promote independence. An acrylic plastic safety mirror can be fitted behind the Wall Ladder allowing children to see themselves whilst using the ladder.

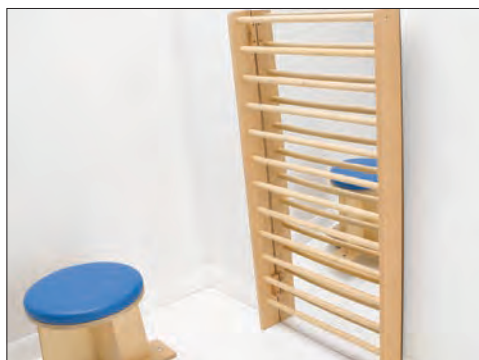

## Floor stepping ladder

Our Floor Stepping Ladders can help with balance and coordination. They are also foldable for easy storage.



## Floor stepping ladder

CODE 4307 (2400 x 500mm)

## Wall ladder

CODE 4334-4335

## Mirror

CODE 4336 (520 x 1200mm)

CODE 4337 (670 x 1200mm)

## High & Low Ladder Back Chairs technical table

all dimensions in mm unless otherwise stated

Back type	High back			Low back		
	1	2	3	1	2	3
Size	1	2	3	1	2	3
Code	4386	4387	4388	4381	4382	4383
Ladder height	900	1130	1355	600	750	900
Seat width	450	450	450	300	350	370
Seat depth	375	400	425	250	290	340
Seat height <sup>1</sup>	375	400	425	290	330	370
Max User weight (kg)	60	60	60	60	60	60
Product Weight (kg)	8	9	10	6	7	8

<sup>1</sup> Measured from floor to top of seat

## Wall Ladder technical data

all dimensions in mm unless otherwise stated

Size	1	2
	Code	4334
Height	1200	1500
Width	600	750
Rung spacing	75	100
Rung diameter	22	25
Max User weight (kg)	50	50
Product Weight (kg)	8	9



“Our Plinth plays a key role in our son’s therapy programme.”

Andrew, Dad, York

## Plinths

Our highly popular Stacking Plinths can be used for individual or group work. For areas that are limited in space, our Folding Plinths provide an ideal storage solution.

## Customise

To meet your child’s needs you can customise your Plinth with a variety of accessories. These are all aimed at supporting your child’s individual therapy programme.

## Cut-out

The option to have cut-outs on either side of your Plinth will give your child more room and better alignment. Cut-outs in a number of sizes are available on request.



provides an ideal storage solution



### Folding & Stacking Plinths technical data

all dimensions in mm unless otherwise stated

Size	1	2	3	4
Length	1070	1500	1675	1830
Width	665	745	840	840
Max User weight (kg)	100	100	100	100
Product Weight (kg)	15	20	25	30

Please choose your code from the following height options

Size	1		2		3		4	
	Folding	Stacking	Folding	Stacking	Folding	Stacking	Folding	Stacking
Height 380mm	4500	<b>4530</b>	4507	<b>4537</b>	4514	<b>4544</b>	4521	<b>4551</b>
Height 460mm	4501	<b>4531</b>	4508	<b>4538</b>	4515	<b>4545</b>	4522	<b>4552</b>
Height 520mm	4502	<b>4532</b>	4509	<b>4539</b>	4516	<b>4546</b>	4523	<b>4553</b>
Height 580mm	4503	<b>4533</b>	4510	<b>4540</b>	4517	<b>4547</b>	4524	<b>4554</b>
Height 640mm	4504	<b>4534</b>	4511	<b>4541</b>	4518	<b>4548</b>	4525	<b>4555</b>
Height 700mm	4505	<b>4535</b>	4512	<b>4542</b>	4519	<b>4549</b>	4526	<b>4556</b>
Height 740mm	4506	<b>4536</b>	4513	<b>4543</b>	4520	<b>4550</b>	4527	<b>4557</b>

# plinth

## optional accessories



### Quick fix plinth tray

CODE 4263-4264

Ideal for a variety of activities  
Easy to use and clean



### Plinth coverboards

CODE 4226-4229 (half)

Transforms a plinth into a table



### Raise blocks

CODE 4210-4214

A quick and simple method of  
raising the height of a plinth



### Suction hand grabs

CODE 4201-4203

Used to stabilise the hand to increase  
function in the opposing hand



### Quick fix handrails

CODE 4205-4207

Will fit along, across or diagonally  
on any sized Slatted plinth



### Handstick

CODE 4197 (single)

CODE 4198 (set of 5)

Can help to strengthen grip  
and increase dexterity

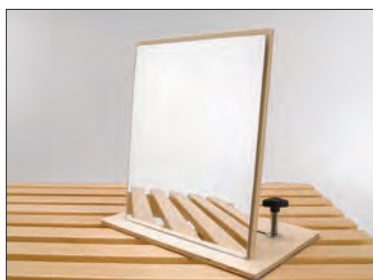

### Quick fix plastic mirror

CODE 4273 small (250 x 200mm)

CODE 4274 large (300 x 200mm)

Easy to attach and allows children to  
see themselves whilst using a plinth



### Dycem non-slip mats

CODE 4703 red or blue (250 x 180mm)

CODE 4706 red or blue (350 x 250mm)

CODE 4709 red or blue (450 x 380mm)

CODE 4700 red or blue (round 190mm)



# therapy bench

buy online

“For our children, we look for products that will have great clinical benefits for the management of their posture.”

Anna, Teacher, Midlands

Our popular height and angle adjustable Therapy Bench together with accessories<sup>1</sup> is designed to assist in a wide range of children's therapy programmes both at home and school.

## Therapy Bench technical data

all dimensions in mm unless otherwise stated

Size	1	2	3	4	5	6
Code	5541	5542	5543	5544	5545	5546
Length	610	610	820	820	820	820
Width	250	300	300	380	325	380
Min height	195	195	280	280	405	405
Max height	295	295	455	455	705	705
Max user weight (kg)	100	100	100	100	100	100
Product weight (kg)	7	8	11	12	15	16



## Colours



# therapy bolster

buy online



## Therapy bolster

CODE 5861 - 5866



## Low end (single)

CODE LG014  
(W 500mm x H 450mm)



## High end (single)

CODE LG013  
(W 500mm x H 700mm)

## Therapy Bolster technical data

all dimensions in mm unless otherwise stated

Size	1	2	3	4	5	6
Code	5861	5862	5863	5864	5865	5866
Length	600	1200	600	1200	600	1200
Height min	300	300	325	325	350	350
Height max	475	475	500	500	525	525
Diameter	200	200	250	250	300	300
Max user weight (kg)	100	100	100	100	100	100
Product weight (kg)	6	11	8	13	10	15

## Colours



Our Therapy Bolster is extremely versatile and can be used just as a roll or built up to have a combination of High ends or Low ends.

<sup>1</sup> Therapy Bench accessories, as shown in the image on the page opposite: Adjustable backrest with pelvic guides CODE **BK091** and Adjustable femoral kneeblocks (pair) CODE **KN002**



# wheely stools

buy online



**adjustable height wheely stool**

## Colours

-  Red upholstery & yellow frame
-  Green upholstery & blue frame
-  Pink upholstery & blue frame



## Therapist's favourite

The Adjustable Height Stool is our most popular wheely stool. It has been designed specifically for working at lower levels with your child, student or client. The stool is designed for sitting astride the narrower side. Available in 3 colour options with a height range of 340-460mm. One size only.

## Adjustable Height Wheely Stool technical data

all dimensions in mm

Code	Size	Colour	Width	Height min	Height max	Max user weight (kg)	Product weight (kg)
4181	1	Red & yellow	450	340	460	100	7
4182	1	Green & blue	450	340	460	100	7
4184	1	Pink & blue	450	340	460	100	7
4192	1	Red & yellow	500	340	460	150	8
4193	1	Green & blue	500	340	460	150	8
4194	1	Pink & blue	500	340	460	150	8

## Round Wheely Stool technical data

all dimensions in mm

Code	Size	Colour	Height	Diameter	Base	Max user weight (kg)	Product weight (kg)
4178	1	Pacific blue	400	360	480 x 48	100	9
4179	1	Deep pink	400	360	480 x 48	100	9



**round wheely stool**

## Colours



## Space saving for therapists

Our space saving, Round Wheely Stool is a popular choice for therapists, teachers and parents when working at a low level with children. The stool comes in our natural wood finish and is available in one size only.

buy online

# ball trails

## Twist 'n' Fun Trails

When children play with our selection of Twist 'n' Fun Trails they can see, feel and hear the movement of the 'racing' colourful balls. Our Trails are perfect for developing children's senses. The Twist 'n' Turn comes with 3 colourful balls, while all other trails come with 10.



### Clown

CODE 42101

Our Clown introduces fun whilst learning. Place the balls into the colourful rings and watch and listen to them race to the bottom. This way of learning encourages motor skills, tracking, anticipation and turn taking.

Height 1260mm

Width 1110mm

Depth 670mm

Product Weight 22kg

developing children's  
senses and building  
confidence



### Twist 'n' turn

CODE 42102

(length 300mm; width 280mm)



### Twist 'n' loop

CODE 42103 (height 750mm;  
width 290mm; depth 500mm)



### Twist 'n' race

CODE 42104 (height 750mm;  
width 320mm; depth 450mm)



### Twist 'n' play wall mounted

CODE 42105 (height 1100mm;  
depth 180mm; width 420mm)

buy online

# body roller

## Rolling to relax

Our Body Roller provides deep pressure therapy as the child crawls between the rollers. The rollers are fully padded which helps your child to relax.

The tension setting can easily be adjusted.

Available in 3 colours, red, green and blue<sup>1</sup>.



<sup>1</sup> Body Roller in Red (CODE 43211), Green (CODE 43221), Blue (CODE 43231). L 1000mm x W 750mm x H 580mm Max user weight 136kg Product weight 30kg

# dreamswing

CODES 41220, 41225, 41230, 41240

Children love the Dreamswing as a cosy retreat, which affords the opportunity to rest and relax. They will particularly turn to the swing to get some rest in stressful situations. The Dreamswing promotes tactile, vestibular and proprioceptive perception and it encourages children to conduct their own activities. It is easy to adapt the Dreamswing to the size and weight of the user. The height can be adjusted with a simple hand movement and using the special harness, new seating and reclining positions can be set. This makes the Dreamswing extremely versatile, suitable for people with allergies and is available in the following sizes:

L, XL, XXL, XXXL

Optional footrests available

Comes with practical accessories:

- A. Height adjustment with rotary swivel
- B. Universal rope bag



[www.smirthwaite.co.uk/dream-swing](http://www.smirthwaite.co.uk/dream-swing)

# frames & swings

vestibular and proprioceptive stimulation can be achieved with our popular swings

## Popular frames

Our popular selection of free-standing suspension systems are designed to be used in conjunction with our sensory swings, platforms and bolsters. They eliminate the need for permanent structural fixings, are made of tubular steel and can be purchased with bright, colourful padding and mats.

## Range of swings

Our range of bolsters and swings are easy to attach to our frames and can be used as part of your child's sensory programme. For instance, our Flexi Bolster provides vestibular and proprioceptive stimulation through gentle rocking or pushing the bolster.





buy online



\* Pictured with optional triple point head

## A, C and O Frames

The A Frame has been designed to handle a weight capacity of 300 kg, this means that you can attach two of our swings or bolsters and use them at the same time. Both the C and O Frames can support rigorous activity and can be fixed to the floor if required.

### C Frame technical data

all dimensions in mm unless otherwise stated

Code (with mats)	Size	Height	Base diameter	Max user weight (kg)	Product weight (kg)
44401	1	2330	1860	150	120

### O Frame technical data

all dimensions in mm unless otherwise stated

Code (with mats)	Size	Height	Footprint	Max user weight (kg)	Product weight (kg)
44502	1	2200	2350	300	120

### A Frame technical data

all dimensions in mm unless otherwise stated

Code (with mats)	Size	Height	Length	Width	Max user weight (kg)	Product weight (kg)
44602	1	2325	5181	1906	300	150

All frames are sold separately, swings are optional extras.

# swings

buy online

make sensory sessions  
enjoyable and refine  
motor co-ordination  
skills



## Swing bolster<sup>1</sup>

Available in 3 sizes and 3 colours.  
CODE 40111 - 40113 (Red)  
CODE 40121 - 40123 (Green)  
CODE 40131 - 40133 (Blue)  
Max user weight - 136kg



## Activity bolster<sup>1</sup>

Available in 3 sizes and 3 colours.  
CODE 40311 - 40313 (Red)  
CODE 40321 - 40323 (Green)  
CODE 40331 - 40333 (Blue)  
Max user weight - 136kg



## Hug 'n' Hold bolster

Available in 1 size and 3 colours  
CODE 40411 (Red)  
CODE 40421 (Green)  
CODE 40431 (Blue)  
Max user weight - 136kg



## Flexi bolster

Available in 1 size and 3 colours  
CODE 40211 (Red)  
CODE 40221 (Green)  
CODE 40231 (Blue)  
Max user weight - 136kg



## Swing platform

Available in 2 sizes and 3 colours  
CODE 4111 & 41112 (Red)  
CODE 41121 & 41122 (Green)  
CODE 41131 & 41132 (Blue)  
Max user weight - 136kg



## Triple point head

CODE 44201  
Allows for 2 x ropes to be attached  
to the C frame.

## Height adjustment suspension kit\*

CODE 44205



**Straight screw  
carabiner**

**Rotational  
device**

**Straight screw  
carabiner**

**Spliced rope  
2m**

**Height adjuster**

**Gate screw  
carabiner**

<sup>1</sup> Requires 2 x suspension kits

<sup>2</sup> All components of Height adjustment suspension kit are available to purchase separately

For technical data please visit our [www.smirthwaite.co.uk/sensory](http://www.smirthwaite.co.uk/sensory)



Colour Ranges

See page 129 for colour options

buy online

# ramp & scooter

## Making sensory fun

Our Ramp & Scooter set make sensory therapy fun and engaging. It can be used in sensory integration sessions to increase the different sensory levels of children. It has been designed to stimulate your child and make their sensory sessions enjoyable.

The set comprises of two varieties of ramps; one of the ramps is angled whereas the other is slightly convexed. The scooter has a flat padded surface that makes it easier for your child to lie in a prone position.

Our Ramp & Scooter set can also be used for proprioception activity, as well as refining motor co-ordination skills. The set comes with 1 x size 2 scooter as standard.

## sensory scooter

### Colours



## Stimulating the senses

Our Sensory Scooters can be used in sensory therapy sessions. The scooters can be used in a variety of ways and can help to develop bilateral motor co-ordination skills.



## Ramp technical data

all dimensions in mm unless otherwise stated

Code	Size	Height	Width	Total Length	Max user weight (kg)	Product weight (kg)
43711 (Ramp & scooter)	1	600	615	3700	80	40

## Sensory Scooter technical data

all dimensions in mm unless otherwise stated

Size	Length	Width	Base Height	Handle Height	Max user weight (kg)	Product weight (kg)
1	900	520	81	175	120	9
2	1100	575	81	205	120	10.5

buy online

# rocking ball

developing core  
balance and social  
skills

## Developing balance

Our Rocking Ball helps to strengthen the core muscles and aids in developing your child's core balance. With its simple and easy to use design, children learn how to control and balance their bodies in a more 'fun' way.

## Rocking ball

CODE 43411

Height 260mm

Overall diameter 500mm

Height from floor 70mm

Max user weight 100kg

Product weight 6kg



# rocking horse

 buy online

## Play time

Our Rocking Horse will provide hours of fun for your child. The contemporary design of the Rocking Horse coupled with the padded seat and back ensures that this product is both attractive and comfortable. The seat depth is easily adjustable and the back can be reclined. The Rocking Horse can be purchased in a variety of colours.

## Rocking Horse codes

Colour	Size 1	Size 2	Size 3
Rouge	43311	43312	43313
Eden	43321	43322	43323
Ocean Blue	43331	43332	43333
Marigold	43341	43342	43343
Lilac	43351	43352	43353
Cherry Blossom	43361	43362	43363
Candy Pink	43371	43372	43373

## Rocking Horse technical data

all dimensions in mm

Size	Seat Height	Overall Length	Overall Height	Overall Width
1	230	650	480	290
2	290	835	620	325
3	335	920	660	375



The Rocking Horse comes with a pelvic strap. Can be used with a harness and pommel (purchased separately)



lovingly created

# introducing sleep systems

## Sleep systems

Sleep systems are not designed to stop the child or adult's movements, but simply to provide different levels of support and prevent the user from getting stuck in harmful positions during the night. Fundamentally, sleep systems should enable the user to enjoy a restful night's sleep. To achieve this, we offer two varieties of sleep system:

**Little Dots** - a supportive system for babies up to 12 months old.

**Snooooooze** - a flexible system for children through to adults.

## Key benefits

Our sleep systems are flexible and highly customisable to the needs of your child or adult. They are adjustable in size (filling can be added or removed) so they grow with your child, are easily portable and have been designed in conjunction with health professionals and carers.

a range to promote integrated posture, for a better night's sleep. Add to your daytime routine for 24hr postural care

We recognise that everyone is different, which is why we have developed and designed systems that:

- Maximise your patient's potential
- Promote postural integrity
- Encourage better sleep patterns
- Work against postural deterioration
- Offer high levels of compliance
- Improve positioning
- Give the carer respite
- Are easily portable
- Enable adjustability
- Are easy to wash & clean





Children spend approx 1/3 of their time in bed, 24 hr postural management is key to their development

### Early intervention

Early intervention is essential for ensuring that your child maximises their social and educational developmental potential. It is vital that your child's needs are identified as early as possible to ensure the best possible quality of life.

### Supportive Little Dots

Little Dots has been designed for new born babies and children up to the age of 12 months old. A highly supportive system, its Segmented Horseshoe and Wedges, dressed with the Fleece Overlay, establishes a profiled shape.

### Adjusting for growth

For young children with low body mass and control, it is important to provide cushioning that is volume adjustable. Little Dots cushions allow you to add and remove filling which, in turn, lets the system grow with your child. Little Dots is lightweight, very portable and offers a highly customisable solution to your child's needs.

## little dots system - key features



**Box W**

**Wedge & ramp (pair)  
Daisy**



**Fleece overlay**

Image presents fleece overlaying Box W, Wedge & ramp (pair) & Daisy



**Segmented horseshoe**

Supports side lying



**Box W**

**Segmented horseshoe**



**Fleece overlay**

Image presents fleece overlaying Segmented horseshoe & Box W



**Little Dots system**

Segmented Horseshoe, Daisy, Box W, Fleece Overlay, 3 sizes of Wedges (pairs) and Wedge & ramp (pair)

buy online

## daytime therapy

Our sleep systems can be also used for day time therapy in conjunction with the Therapy mat, which is hook & loop receptive.



help achieve an excellent trunk and leg position, whilst stabilising the pelvis



### Therapy mat

CODE 9002 size 1, 9003 size 2  
Can be used in sensory rooms and for stretching and therapy activities

Size 1 500 x 700mm  
Size 2 1730 x 1000mm



### Sidney with wrap

CODE 9040  
A highly portable multi-use side lying positioning system

## little dots components (paediatric)



### Little Dots system

CODE 9030  
Segmented Horseshoe, Daisy, Box W, Fleece Overlay, 3 sizes of Wedges (pairs) and Wedge & ramp (pair)



### Fleece overlay

CODE 9038  
Double sided fleece is used to overlay on the components



### Daisy

CODE 9033  
Provides head support  
Head angle is increased when Daisy petals are folded



### Segmented horseshoe

CODE 9032  
Encourages alignment



### Box W

CODE 9031  
Supports your child's leg  
Prevents rotation and risk of dislocation



### Wedge & ramp (pair)

CODE 9034  
For less demanding children, gives pelvic positioning and arm support



### Wedge (pair)

CODE 9035 size 1, 9036 size 2, 9037 size 3  
Used to profile the Horseshoe or other components

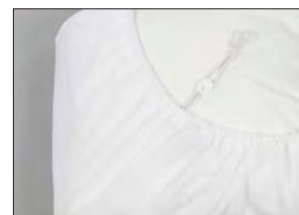

### Mattress sheet

CODE 9001  
Hook & loop receptive sheet  
Fits standard single mattress, custom sizes available



buy online



### Flexible Snooooooze

This flexible sleep system is designed for children and adults. It is lightweight, highly portable and highly adjustable to cater for the growth and the needs of your child.

### Support in 3 lying positions

The Snooooooze system supports the user in supine (on their back), side and semi-prone lying positions. This key feature enables us to accommodate and correctly position posture overnight, whilst maintaining a high level of comfort.

### Supine lying

To ensure correct positioning both during the day and night, we stabilise the pelvis. The pelvis is the foundation of good posture, and is therefore the first area we evaluate when conducting an assessment. Using a component like the W Leg Trough, we aim to draw the legs into mid-line.

## supine positioning components



### T-roll (size 1 & 2)

Inhibits adduction  
Supports the user's legs in abduction



### W leg trough (size 1 - 5)

**Pictured using without the wrap**  
Positions the user's legs  
Prevents rotation and risk of dislocation



### Standard W leg trough with wrap (size 1 - 5)

The adjustable wrap provides extra support for the abducted legs



### Twin leg wedge (size 1 - 3)

Gives leg support and provides support behind the knee



### Foot support

Positions and supports the feet in alignment at various angles



### Foot support

See product opposite  
**Roll (size 1 & 2)**  
Use as a head support or behind the knees



### Side lying

The Body roll has heralded a new stage in side lying, and can help achieve an excellent trunk and leg position for both left and right side lying. It is most effective for when the trunk has shortening sides and the legs are windswept. Alignment of the legs is achieved with a Pillow between the user's legs. The final key of achieving a good posture is to support and position the head.

### Semi prone lying

Evolved from our work in side lying, semi prone lying is best achieved through use of our Body Roll. This very 'cuddleeable' roll effectively supports the user's head and knees at the same time. The key benefit of the Snooooooze sleep system is that is extremely customisable, so that the user can sleep in a position that is suitable for his or her needs.

### Sleep for everyone

When the user struggles to sleep, it has a direct impact on the sleep patterns of every family member. Parents and siblings can be left exhausted, unable to think clearly and struggling to cope with their daily activities. By ensuring that the user has a good night's sleep, it also means that you and your family will enjoy the many benefits of sleep.

## side lying & semi prone components

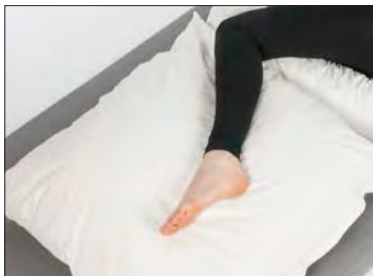

#### Pillow size (1 & 2)

Very versatile  
Use as a head support or between the legs in side lying



#### Body roll (size 1, 2 & 3)

Supports head, trunk and legs

#### Pillow size (1 & 2)

See product opposite



#### Roll (size 1 & 2)

Use as a head, knees or back support

#### Curved wedge (3 sizes)

Supports the body or other components



#### Banana cushion (size 1 & 2)

Head support in side lying  
Supports feet or other parts of the body



#### Horseshoe (little dots)

Use between the legs in side lying  
Use as a full supine support



#### Star head support little dots (size 1 & 2)

Use as a head support with profiling points

# snoooooze components

buy online



## T-roll

Paediatric and adult size  
Inhibits adduction  
Supports your child's legs in abduction



## Body roll

Paediatric and adult size  
Provides the ideal positioning to enable side lying, giving support to head, trunk and leg



## Roll

Paediatric and junior size  
Supports down the back or behind the knees



## Horseshoe

Paediatric and adult size  
Encourages alignment and is suitable for supine and side positioning



## W leg trough with wrap

Paediatric to adult size  
The adjustable wrap provides extra support for the legs



## Twin leg wedge

Paediatric to small adult  
Gives leg support and provides support behind the knee



## Foot support

Paediatric  
Positions and supports the feet in alignment at various angles

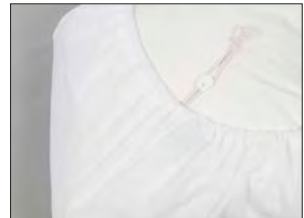

## Mattress sheet

(Cot, single and double size)  
Hook & loop receptive sheet  
Fits standard single mattress, custom sizes available



## Pillow

Paediatric to small adult  
Very versatile  
Use as a head support or between the legs in side lying



## Banana cushion

Paediatric to adult  
Versatile component that can be used for most parts of your child's body



## Star head support

Paediatric and junior size  
Gives head support  
Points of the Star can be folded for angled support



## Curved wedge

Paediatric to small adult  
Use either directly supporting the body or other components



## Wedge

Paediatric  
Supports head in mid-line



## Tri-fold

Paediatric to adult  
Use either directly supporting the body or other components



# soft protection helmets

buy online

soft, cool head protection  
for active people and  
people with special needs



## An non-stigmatizing solution that are loved by people with special needs.

Ribcap is committed to innovation in design and development of products that reduce the risk of traumatic brain injury for people with medical challenges, special needs, and others at risk during work and play activities. Ribcap designs products based on feedback from parents, patients and medical experts in traumatic brain injury risk reduction.



## Protect yourself: soft protection helmets for your everyday life and special needs!

Traumatic brain injury (tbi) is a serious public health problem worldwide. A head injury resulting from a fall and or impact to the head is a serious and growing problem for all ages. Statistics have shown that 64,000,000 of yearly falls are without protective headgear need medical assistance, resulting in mild to severe head injuries. Ribcap hats offer a solution to avoid this tragedy with high-quality head protection, embedded with unique absorbing foam to reduce the force of impact.

## Excellent soft protection headgear for:

- reducing impact during autism headbanging
- general autism & epilepsy helmet
- general seizure helmet
- hemophilia and other bleeding disorders
- cerebral palsy & reduced mobility disorders oncology
- soft helmet for special needs and other disabilities
- everyday head protection
- soft protection for active kids and adults
- prevention of bumps and bruises
- use as a soft helmet for non-high-risk activities
- recreational ice skating, curling, hiking, etc.
- use as soft safety protection for hiking and other outdoor activities
- head injury recovery
- reduced stability and mobility
- staying active and feel secure
- use as a fall injury management device
- use as your everyday head protection
- seniors with special needs and other neurologic disorders.

# the range



## Protective beanies & caps.

Ribcap stylish safety helmets and cool beanies are designed to keep you active! Ribcap soft helmets are integrated with a unique shock-absorbing foam to reduce any force of impact.

The unique features of all the beanies and caps include the following; cooling/quick dry/foldable/water and dirt resistant/chin strap/washable/all season wear.



### Iggy

COLOURS - Stripy / Brown  
Sizes small 53-55cm / medium  
56-58cm / large 59-61cm



### Hardy

COLOUR - Azure / Sand / Platin  
Sizes small 53-55cm / medium  
56-58cm / large 59-61cm



### Lenny

COLOURS - Anthracite / Grey /  
Marine / Bordeaux / Khaki / Rose  
Sizes small 53-55cm / medium  
56-58cm / large 59-61cm / x-large  
62-64cm (Anthracite or Grey only)



### Baseball Cap

COLOURS - Navy / Red / Platin  
Sizes small - medium 53-58cm /  
large - xlarge 59cm-65cm



### Bieber Kids

COLOUR - Brown  
Sizes mini 47-49cm / midi 50-52cm /  
maxi 53-55cm



### Lenny Kids

COLOUR - Anthracite / Grey  
Sizes mini 47-49cm / midi 50-52cm /  
maxi 53-55cm

**Get your soft protection headgear today! Stay safe and fashionable!**



enchancing lives...

# harnesses

## Added support

All of our harnesses provide additional support to give your child maximum benefit from their chosen equipment.

## Easy to adjust

Our harnesses can be easily adjusted to accommodate your child's needs and growth.

## Postural benefits

The harness helps to maintain postural alignment in the upper body, which helps to promote functions in the upper limbs.

## samba and hardrock harnesses

A choice of harnesses to ensure that your child maintains postural alignment.



**Soft cross harness**

CODE HN056 – HN059



**Shoulder harness for the mid-line harness**

CODE HN027 – HN030



**Mid-line support harness with sheepskin pad**

CODE HN023 – HN026

## heathfield, brookfield and combi harnesses



**Teenage harness**

CODE HN051 – HN052

Available in 2 sizes

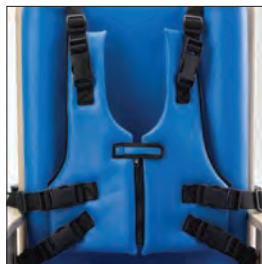

**Jacket (padded with zip)**

CODE HN042 – HN044

Available in 3 sizes



**Butterfly harness**

CODE HN049

Available in 1 size



**4-point harness**

CODE HN001 – HN004

Available in 4 sizes for the Heathfield and Combi

CODE HN002 – HN004  
Available in 3 sizes for Brookfield



**Bib harness (padded)**

CODE HN045 – HN047

Available in 3 sizes



**Waistcoat harness**

CODE HN009 – HN011

(Heathfield/Brookfield)

CODE HN053 – HN055

Available in 3 sizes



**Groin harness**

CODE HN039 – HN041

Available in 3 sizes

# sandals

## Feet support

Children's feet also require additional support to help maintain the position of their hips. Feet support enhances good balance and enables freedom of movement in the upper body.



### Ferndale sandals (pair)

CODE SL001 - SL004  
Available in 4 sizes



### Cocoon sandals (pair) – velcro<sup>1</sup>

CODE (standard) SL005, SL007, SL009, SL011, SL013 (narrow) SL017, SL019, SL021, SL023



### Cocoon sandal – ski buckles (pair)<sup>1</sup>

CODE (standard) SL006, SL008, SL010, SL012, SL014 (narrow) SL018, SL020, SL022, SL024



### Cocoa sandals (pair)

CODE SL045, SL047, SL049, SL051  
Velcro fixing only  
Available in 4 sizes



### Soft insoles (pair) Cocoon

CODE (standard) SL025, SL029 (narrow) SL030, SL034



### Sheepskin liners (pair) Cocoon<sup>2</sup>

CODE (standard) SL035, SL039 (narrow) SL040, SL044



### Sandal raisers (pair)<sup>3</sup>

CODE SL055 - SL069  
Available in 5 sizes & 3 heights



### Sandal step wedges (pair)

CODE SL053 - SL054  
Available in sizes 1 & 2



### Heel huggies (pair)<sup>4</sup>

CODE HH001 - HH005  
Available in 5 sizes

## battery extras

Battery extras CR001 and BP003 can be used for the following products:

- Samba
- Whirl
- Supro



### Spare battery charger

CODE CR001



### Spare battery pack with control box

CODE BP003



### Charging station for mobi changers

CODE CB008 (wall charger and battery kit)

CODE BP005 (battery only)

1 Narrow width only available in 4 sizes

2 Only available at time of order for Cocoon sandals

3 Available in three heights 12mm, 18mm & 24mm

4 Heel huggies plate may be required for some applications



# colours

## New Moxxa range - brushed/soft finish smooth vinyl



## Just Colour range - vinyl

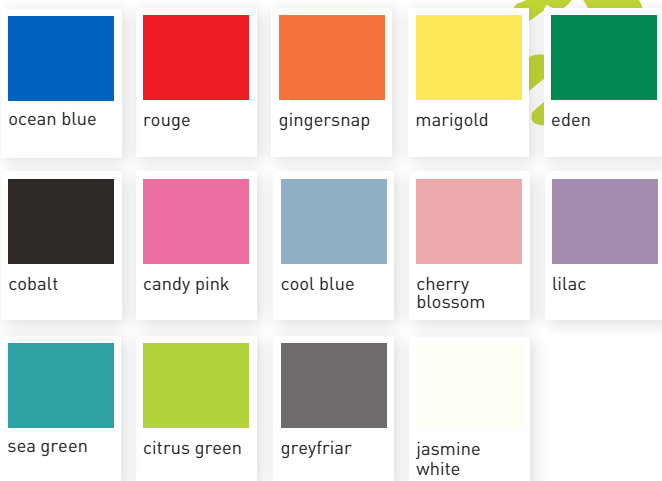

Just Colour range can be used on most products

## Dartex fabric range

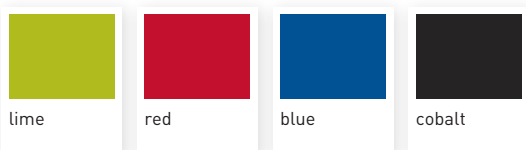

Dartex can be used on the juni, zoomi and zoomi +

Colours are a guide only and may vary due to limitations of the print process. Material samples are available upon request. Colour range may change without prior notice, we try to colour match where possible.







seating standing toileting bathing changing showering sleeping therapy sensory

a helping hand around the World



**CONTÁCTANOS**



**OfficeMart**

#Sololosmejoresmuebles



MXL. (686) 558 7874  
TJN. (664) 689 2823  
ENS. (646) 144 6382



[ventas@oficemart.mx](mailto:ventas@oficemart.mx)



[oficemart.mx](http://oficemart.mx)



[OficeMart](https://www.facebook.com/OficeMart)